

# TOTO

**TOTO ASIA OCEANIA  
PTE. LTD.**

10, Eunos Road 8, #12-07, Singapore Post Centre. Singapore 408600.  
Phone : +65-6744-6955 Fax : +65-6841-0819 <http://asia.toto.com/>

**TOTO ASIA OCEANIA  
PTE. LTD.**

Middle East Branch LOB19-1701-1702, Jebel Ali Free Zone, P.O. box 261804, Dubai U.A.E.  
Phone : +971-4-886-5983 Fax : +971-4-886-5986 <http://asia.toto.com/>

**TOTO ASIA OCEANIA  
PTE. LTD.**

Manila Representative Office. Unit 1010, 10th Floor Rufino Building, Ayala Avenue cor.V.A.  
Rufina Street, Makati City, 1226 Philippines.  
Phone : +63-2-887-6643 Fax : +63-2-887-4084 <http://asia.toto.com/>

**Yangon Branch**

#303, Prime Hill Business Square, No.60, Shwe Dagon Pagoda Road,  
Dagon Township, Yangon, Myanmar  
Phone : +95-1-382710, +95-1-382720 Fax : +95-1-382638

**TOTO (THAILAND) LTD.  
Spare Part and  
After Service Center**

77 Moo 5 HSIL Industrial Zone T.Nong -Plamor A.Nong-Khae Saraburi 18140 Thailand  
Phone : +66-92-246-5880, +66-92-246-6612, +66-36-382-760  
Fax : +66-2-650-9923 <http://th.toto.com/en/index.php>

**TOTO INDIA INDUSTRIES  
PVT. LTD**

101, Kamla Executive Park, Opp. Vazir Glass Works,  
Off. Andheri Kurla Road, Andheri (East), Mumbai 400 059, India.  
Phone : +91-22-4022-3717 / 3718 Fax : +91-22-4022-3719 <http://asia.toto.com/>

**TOTO VIETNAM  
Co., Ltd.**

R. 810, Daeha Business Centre, 360 Kim Ma St., Ba Dinh Dist., Ha Noi City  
Phone : +84-4-37714354 Fax : +84-4-37714355 <http://toto.com.vn/>

- You are advised to record the following information to allow quick service.

Date of purchase :	Name of shop :
Date : year month day	Tel : (     )

2017.11.15  
H0A083 (D07113)

# TOTO

## NEOREST NX

**NX2 CS901\*\*\***

**NX1 CS900\*\*\***

Instruction Manual

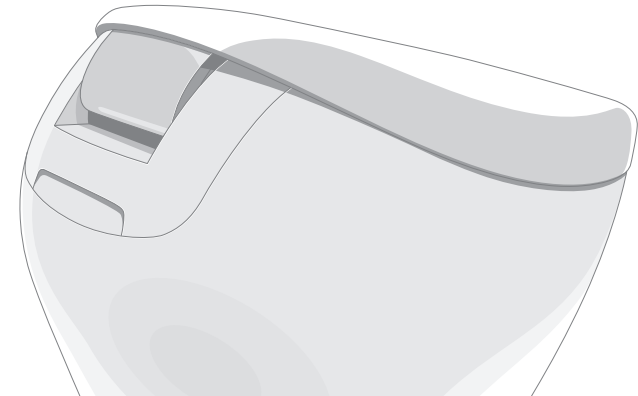

- Thank you for your recent purchase of this product.  
Please read the enclosed information to ensure the safe use of your product.
- Be sure to read this Instruction Manual before using your product and keep it in a safe place for future reference.

The available functions vary according to the model.

Functions		Your Model	Product name (Model)		Ref. Page
			NX2	NX1	
		Part No.	CS901 ***	CS900 ***	
Basic Functions	Cleansing	Rear cleansing			18, 19
		Rear soft cleansing			
		Front cleansing	●	●	
		Wide front cleansing			
	Changing the cleansing method	Wand position adjustment			
		Water pressure adjustment			
		Oscillating cleansing	●	●	
		Pulsating cleansing			
		Personal setting lock			
	Drying	Warm air drying	●	●	
Changing the temperature	Temperature adjustment	●	●	22, 23	
Sanitary Functions	Removing odors	Deodorizer	●	●	16, 17
	"ewater+" sanitizing	Auto wand CLEAN	●	●	
		Auto bowl CLEAN	●	●	
	Maintaining the bowl unit cleanliness	Photocatalyst cleaning	●	-	
Convenience Functions	Flushing	Remote control flushing	●	●	19
		Auto flushing	●	●	16, 17
	Opening and closing	Opening and closing the toilet seat with remote control	●	●	19
		Auto open / close (lid)			
	Lighting up	Soft light	●	●	16, 17
	Heating the toilet seat	Instant heated seat	●	●	
		Save energy by lowering the toilet seat temperature	Auto energy saver+ Timer energy saver	●	●
	Lower the bowl unit water level	Lower water level	●	●	41
Maintenance	Bowl unit cleaning			44	
	Wand cleaning	●	●	46	

☑ Check your model name and write a check mark in this field as needed.



# Keep It Clean

## Sanitary Toilet

Keep the toilet bowl clean with "ewater+" and "Photocatalyst cleaning"<sup>1</sup>.

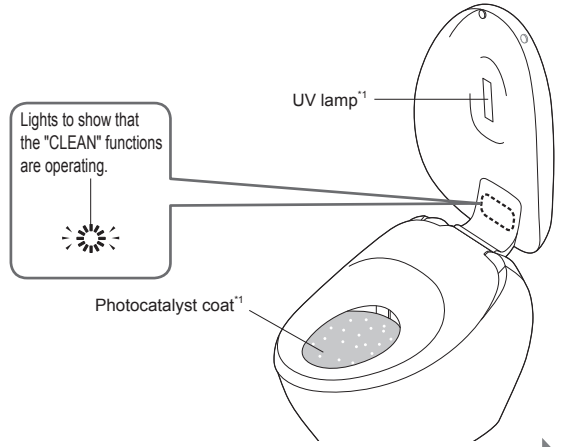

The self-cleaning functions operate automatically. (Page 16, 17)

	As you approach	As you sit	As you stand up	As you leave
Removing odors inside the bowl unit.		Deodorizer	Auto power deodorizer	
Sanitize the bowl unit with "ewater+"	Auto bowl CLEAN			Auto bowl CLEAN
Sanitize the wand with "ewater+"			Auto wand CLEAN	
The bowl unit is sanitized by the UV lamp.				Photocatalyst cleaning <sup>1</sup>

\*1 For units with the "Photocatalyst cleaning" function only.

## Table of Contents

Safety Precautions .....4  
 Operational Precautions .....9  
 Parts Names .....12  
 Preparation .....14

**Basic Operations** .....16  
 ● How the Automatic Functions Work 16  
 ● Using the Remote Control .....18  
 ● About the Menu Screen .....20

**Temperature Adjustment**  
 (Warm Water, Toilet Seat, Drying) .....22

**Energy Saver Features** .....24  
**Various Usage** .....28  
 ● Settings List .....28  
 ● Automatic Functions .....30  
 ● Language Settings .....38  
 ● Other Settings .....40

**Maintenance** .....42  
 ● Top Unit .....43  
 ● Bowl Unit .....44  
 ● Wand .....46  
 ● Deodorizing Filter .....47  
 ● Water Filter Drain Valve .....48  
 ● Water Filter (Bowl Unit) .....50

**What to Do?** .....52  
 ● If the water does not flow due to a power outage .....52  
 ● If the water does not flow due to a water service interruption .....56  
 ● If you cannot operate with the remote control .....57  
 ● Freeze Damage Prevention .....58  
 ● Long Periods of Disuse .....59  
 ● Removal of Display Panel .....62  
 Troubleshooting .....63  
 Specifications .....73  
 Safety Guidelines .....74  
 Warranty .....75

Introduction

Operation



Maintenance

Reference



# Safety Precautions

These precautions are important for safe usage. Be sure to follow them and use the product correctly.

## Symbols and Meanings

	<b>WARNING</b>	May result in death or serious injury.
	<b>CAUTION</b>	May result in injury or property damage.

The following symbols are used to indicate important safety instructions for the use of the product.

Symbol	Meaning
	This symbol indicates a prohibited use of the product.
	This symbol is used to indicate a required step in the use of this product.

- This product is classified as Class 1 Equipment and must be grounded.
- Install this equipment where an electrical outlet is accessible.
- This appliance is not intended for use by persons (including children) with reduced physical, sensory or mental capabilities, or lack of experience and knowledge, unless they have been given supervision or instruction concerning use of the appliance by a person responsible for their safety.  
Children should be supervised to ensure that they do not play with the appliance.
- Use the new hose set included with this equipment. Do not reuse an old hose set.

## WARNING

	<b>Do not plug or unplug the power plug or power cord with wet hands.</b>
	• Doing so may cause electrical shock.
	<b>Do not get any water or cleaning solution on the top unit, power plug, or power cord.</b>
	• Doing so may cause fire, electrical shock, heat, or a short circuit. • Doing so may cause the product to crack, resulting in injury or water damage.
	<b>Never disassemble, repair, or alter.</b>
	<b>Do not use tools in places other than designated.</b>
	• Doing so may cause fire, electrical shock, overheating, short circuit or breakdown.
	<b>Do not install the product on moving vehicles such as wheeled vehicles or boats.</b>
	• Doing so may cause fire, electrical shock, short circuit or malfunction. • The toilet seat, toilet lid, or other parts may come loose and fall off, resulting in injury.

## WARNING

### Do not use the NEOREST if a malfunction occurs.

- In case of breakdown or other problem, be sure to cut off power by means such as unplugging the power plug or switching the breaker in the distribution board to OFF.  
Close the water shutoff valve to stop water supply.

#### Possible malfunctions:

- Water is leaking from a pipe or the top unit.
- The product is cracked or broken.
- The product makes a strange noise or emits a strange odor.
- The product emits smoke.
- The product is abnormally hot.
- The bowl unit is clogged.
- The toilet seat cushion is out of place.

- Continued use after malfunction could cause a fire, electrical shock, heat, short circuit, injury or water damage.

### Only use tap water or potable well water (underground water).

#### Do not use seawater.

- Doing so may cause irritation to the skin and malfunction.

### Do not touch the power plug or power cord during thunderstorms.

- Doing so may cause electrical shock.

### Do not allow the water supply hose to touch the power plug, outlet, or power cord.

- Doing so may cause condensation resulting in a fire, electrical shock, heat or a short.

### Do not do anything that may damage the power cord or power plug.

Do not strike, yank, twist, excessively bend, damage, alter, or heat the power cords. Also, do not place anything heavy on, bind or pinch the power cords.

- Using a damaged power cord may result in fire, electrical shock, heat, or short.

### Do not use a loose or faulty electrical outlet.

- Doing so may cause fire or a short circuit.

### Do not use any outlet or wiring equipment beyond its specified rating.

- Plugging too many plugs into the same outlet, for example using outlet splitters, can cause fire due to heat.

### Do not use any power supply other than the one specified. AC 220-240V, 50Hz/60Hz

- Doing so may cause fire or excessive heat.

### Do not stick a finger or anything else into the warm air outlet.

Do not place anything on the warm air outlet or drape clothes over it.

- Doing so may cause burns, electrical shock, or malfunction.

### Keep cigarettes and other open flames away from the product.

- Failure to do so may cause fire.

# Safety Precautions (Continued)

## WARNING

### Refrain from sitting on the seat for long periods.

- It may cause low-temperature burns.
- To prevent the following persons from getting a moderate temperature burn during use, other person should turn off the toilet seat heater and set the dryer temperature to "Low".
  - Young children, the aged and other users unable to set the temperature appropriately themselves.
  - The ill, physically disabled and others who do not have freedom of movement.
  - Those using any medicines that cause drowsiness (sleeping or cold medicine), those who have been drinking heavily, anyone severely fatigued and anyone else liable to fall asleep.

**This is an electrical product. Do not install it anywhere water is likely to get on the product or anywhere with humidity high enough that water is likely to form on the surface of this product. When using the product in a bathroom, install a fan or ventilation port and ensure good air flow through the bathroom.**

- Failure to do so may cause fire or electrical shock.

### Always connect the NEOREST to the cold water supply.

- Connecting to hot water supply may result in burns and equipment damage.

### Check that an appropriate ground is installed.

- If the ground is not installed, if there is a breakdown or electrical current leak, the lack of a ground could cause electrical shock.  
For the ground, use copper wire with a ground resistance of 100  $\Omega$  max. and a diameter of 1.6 mm min.
- \* If there is no ground installed, ask the contractor who did the installation to install the ground.

### Make sure that a properly grounded (3 prong) outlet has been installed.

- Failure to install a grounded outlet could cause electrical shock in the event of a malfunction or short circuit.

### Insert the power plug securely into the outlet.

- Failure to do so may cause fire, heat or short circuit.

### Check that the power plug is waterproofed with silicone rubber.

- A power plug that is not water-proofed may cause fire or an electrical shock.
- \* If the power plug is not water-proofed, ask the contractor who did the installation to water-proof it.

### To unplug, hold the power plug, not the power cord.

- Do not unplug by pulling the power cord.
- Pulling on the power cord may cause damage and result in fire or heat.

**If the electric cord is damaged, avoid danger by having the manufacturer's repair department or equivalent specialist replace it.**

### Always switch the breaker on the distribution board to OFF before cleaning or maintenance.

- Failure to do so may cause electrical shock or malfunction.

### When leaking battery fluid adheres to your body or clothes, wash it away with clean water.

- The fluid may damage your eyes or skin.



## WARNING



**Preliminary studies in females suggest that overuse of continuous spraying can increase the possibility of vaginal mucosa drying and a potential reduction in desirable microbial organisms. Although these studies have not been validated, please consult your healthcare provider for concerns regarding whether these circumstances may apply to you.**

**More importantly, if you are an individual suffering from any immune deficiency as a result of disease, chemotherapy, or other medical condition compromising the immune system, you should consult your healthcare provider before using this product.**

## CAUTION



### If the product is damaged, do not touch the damaged section.

- Doing so may cause electrical shock or injury. Replace it immediately

### Do not apply strong force, mechanical shock, step on or stand on the toilet seat, toilet lid or top unit. Also do not place any heavy object on the toilet seat, toilet lid, or top unit.

- Doing so could cause cracking or cause the toilet seat or lid to come loose and fall, resulting in injury.
- Doing so could damage the product and cause injury or water damage.

### Do not lift up this product by the toilet seat or lid.

### Do not raise the toilet seat or lid while objects are resting on top of the unit.

- The toilet seat, toilet lid, or other parts may come loose and fall off, resulting in injury.

### When cleaning or maintaining the plastic parts (toilet seat, toilet lid etc.) or the water supply hose, use a kitchen cleaner diluted with water. Do not use any of the following.

Toilet cleaner, household cleaner, benzene, paint thinner, powdered cleanser or nylon scrubbing brush.

- These items may damage or crack the plastic and cause injury or malfunction.
- These items could damage the water supply hose and cause a water leak.

### To prevent a sudden water leak, do not remove the water filter drain valve when the shutoff valve is open.

- Doing so will cause water to spurt out. (Refer to Page 49 for instructions on cleaning the water filter drain valve.)

### Do not fold or crush the water supply hose; do not damage by cutting with a sharp object.

- Doing so may cause water leaks.

### Do not pour hot water into the toilet.

- Doing so may result in damage to the toilet, injury or water damage.

### Do not flush anything other than bodily waste and toilet paper. Also, do not flush too much toilet paper.



### Do not flush the bowl unit if it is clogged.

- Doing so may clog the toilet, causing waste water overflow, and water damage.

### Keep the bowl filled with water.

- Failure to do so may cause sewer gas, chlorine gas, or hydrogen sulfide to corrode facilities and equipment.

## Safety Precautions (Continued)

 <b>CAUTION</b>	
	<p><b>Do not look directly at UV light*1.</b></p> <ul style="list-style-type: none"> <li>• Doing so may cause eye or skin irritation.</li> <li>• There are no user replaceable parts. Shall be serviced by qualified personnel only.</li> </ul>
	<p><b>If a water leak should occur, always close the shutoff valve.</b></p> <p><b>When the ambient temperature is likely to drop to 0°C or lower, prevent damage to the pipes and hoses due to freezing.</b></p> <ul style="list-style-type: none"> <li>• Frozen water pipes could cause the top unit and the pipes to break, resulting in a water leak.</li> <li>• Regulate the room temperature to prevent the pipes and hoses from freezing during cold months.</li> </ul> <p><b>When not using the NEOREST for a long time, close the shutoff valve, drain the water from the top unit and water supply hose, and then turn off the breaker on the distribution board.</b></p> <ul style="list-style-type: none"> <li>• When using the product again, allow the product to refill with water first. Otherwise, the water in the tank might become contaminated and cause skin inflammation or other problems. (Refer to Page 61 for instructions on replenishing the water.)</li> <li>• Leaving the power on may cause fire or heat.</li> </ul> <p><b>When installing the water filter drain valve, make sure that it is securely tightened in its proper position.</b></p> <ul style="list-style-type: none"> <li>• Failure to securely tighten it may cause a water leak.</li> </ul> <p><b>If the bowl unit is clogged, switch the breaker on the distribution board to OFF and remove the clog.</b></p> <ul style="list-style-type: none"> <li>• If the auto flush were allowed to function, it would make the wastewater in the bowl unit overflow and may result in water damage.</li> <li>• Use commercially available tools that are made for unclogging the bowl unit to remove the clogging.</li> </ul> <p><b>Always flush, even after just urinating.</b></p> <ul style="list-style-type: none"> <li>• Failure to do so may clog the toilet, causing waste water overflow and water damage or inadequate flushing of the bowl unit.</li> </ul> <p><b>Wipe any urine, condensation, cleaner, water, etc. that has gotten on the floor with a well-wrung mop or cloth.</b></p> <ul style="list-style-type: none"> <li>• Failure to do so may cause staining and corrosion of the floor.</li> </ul> <p><b>Make sure of the plus and minus signs on the batteries before inserting them.</b></p> <p><b>Remove depleted batteries immediately.</b></p> <p><b>When replacing the batteries:</b>  <b>Replace both batteries with new ones.</b></p> <p><b>Use the same brand for both new batteries (any brand available).</b></p> <ul style="list-style-type: none"> <li>• Failure to do so may cause the batteries to leak fluid, generate heat, rupture, or ignite.</li> </ul> <p><b>When the product is supposed not to be used for long time, remove the batteries from the remote control and battery box.</b></p> <ul style="list-style-type: none"> <li>• Failure to do so may cause the batteries to leak fluid.</li> </ul>

\*1 For units with the "Photocatalyst cleaning" function only.

## Operational Precautions

### ■ About the built-in seat sensor

When you sit on the toilet seat, the seat sensor turns ON, enabling you to use various features. (The deodorizer starts when the seat sensor makes a detection.)

● A label indicating the position of the seat sensor is attached to the seat.

Detection by the sensor may be difficult when the toilet is used by someone small, such as a child, depending on how the person sits. Sit on the seat with the label as a guide. (The label can be peeled off).

● Sit so your skin is in direct contact with the seat sensor. The seat sensor may not detect properly if there is a seat cover or clothing.

● Water droplets collecting on the seat sensor may cause the main unit to malfunction. Be sure to wipe off any water droplets on the sensor.

<Detection range>

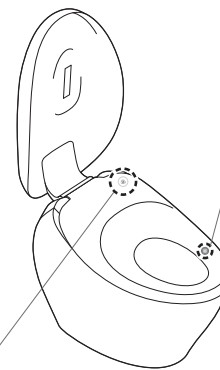
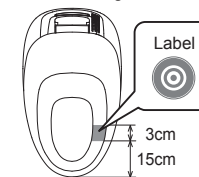

### ■ About the Flush button

The toilet can be flushed when this button is pushed.

● Push the FLUSH button with your finger directly on the button.

● Water droplets collecting on the FLUSH button may cause the main unit to malfunction. Be sure to wipe off any water droplets on the button.

# Operational Precautions (Continued)

## ■ For prevention of malfunctions and failures

- Switch the breaker on the distribution board to OFF if there is a risk of lightning.
- A toilet seat cover or a toilet lid cover cannot be used. (The seat sensors may not function properly. Additionally, the toilet seat and lid may not open or close properly.)  

- Do not urinate on the top unit, toilet seat, or wand. (Doing so may cause a failure or discoloration.)
- Do not apply strong forces to the control panel of the remote control.
- When using a toilet cleaner to clean the toilet, rinse it off within 3 minutes and leave the toilet seat and toilet lid open.
  - Wipe off any cleaner that remains on the bowl unit. (If vapor from a toilet cleaner enters the top unit, it may cause a malfunction.)
- Do not expose to direct sunlight. (Doing so may cause changes in color, irregular heated seat temperature, or operation failure of the remote control.)
- Use radios, etc. away from the product. (The product could cause interference with the radio signal.)
- If you use a booster seat for infants or a soft highchair, remove it after use. (Keeping it installed may prevent some of the functions from being used.)
- Do not apply force to the remote control. (May cause malfunctions.)  
To prevent the remote control from being dropped, set it in the hanger when you are not using it. Be careful not to expose it to water.
- Do not place anything on top of the toilet seat. Additionally, do not press it by hand. (Doing so may activate the seat sensor, causing the floor to get wet if buttons on the remote control are touched and warm water comes out from the wand.)

## ■ For prevention of damage

- Wipe plastic areas such as the toilet seat, toilet lid, and remote control with a soft cloth tightly wrung out with water.

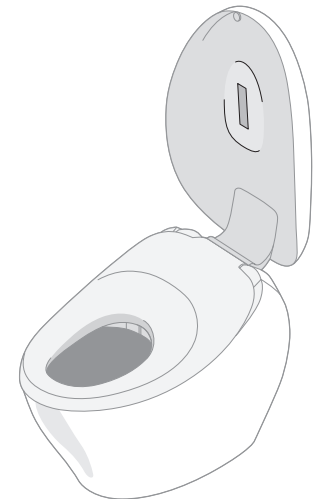

- Do not lean against the toilet lid.



This telecommunication equipment is in compliance with NTC requirements.

# Parts Names

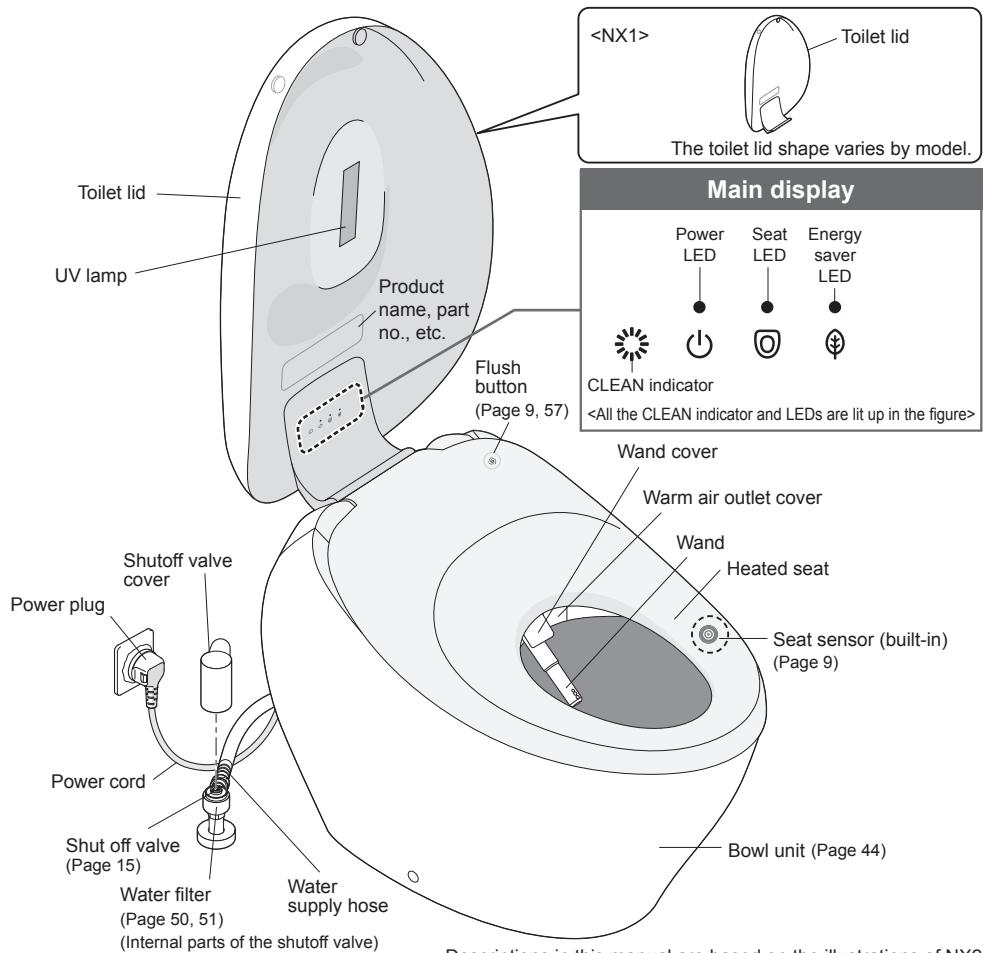

Descriptions in this manual are based on the illustrations of NX2

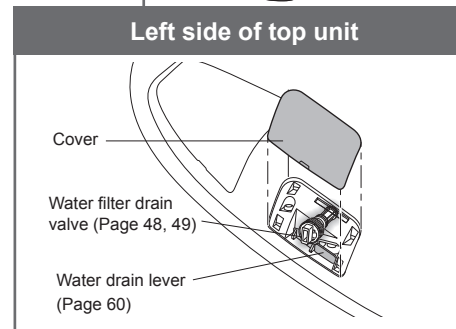
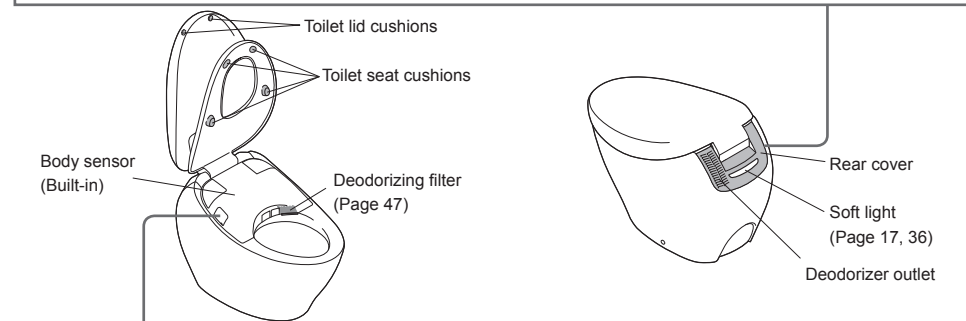
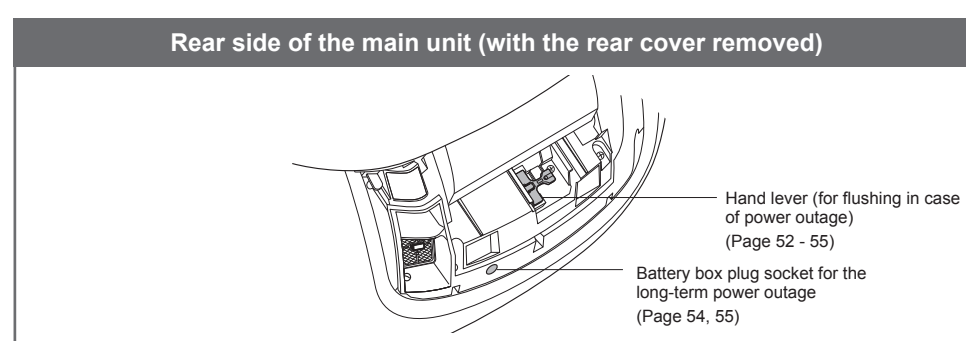



### 1. Insert the battery

- 1** Remove the remote control from the hanger.

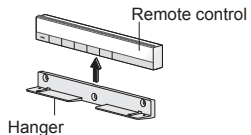

- 2** Open the battery cover and insert two AA batteries.

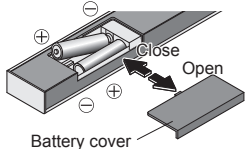

- When batteries are properly inserted, temperature levels appear on the display of the remote control (back side).  
→ When the temperature levels are not displayed, perform step ③ of "Language Settings" in page 38.
- The display goes out when no button on the remote control is pressed for about 60 seconds or more.

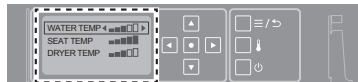

- 3** Mount the remote control in the hanger.

### If the remote control is secured (for anti theft)

- 1** Remove the screws (2, left and right) from the remote control fixture.

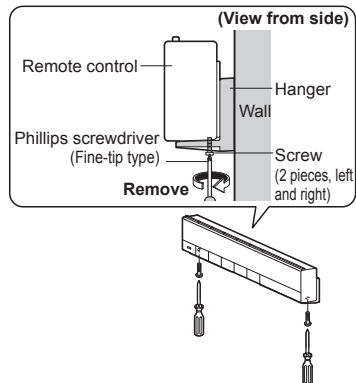

- 2** Remove the remote control from the hanger.

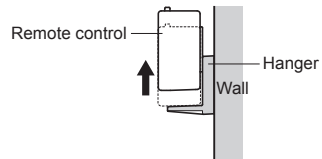

- To secure the remote control again  
Tighten and fix the screws (2, left and right).  
(Overtightening may cause damage to parts such as the hanger.)

#### ■ About the batteries

- Use dry cell, alkaline batteries.
- Be sure to follow "Safety Precautions" to prevent the batteries from rupturing or leaking fluid, etc. (Page 6, 8)

### 2. Turn on the power

- 1** Switch the breaker on the distribution board to ON.  
• The wand extends and then retracts.
- 2** Check that the "Power" LED is lit up.  
• When it is off, switch the "Power" to "ON".

#### To operate from the back of remote control

- Press "Power ON/OFF" button for about 3 seconds or longer

#### To operate from the front of remote control

- \* Recommended if the remote control is locked to prevent theft.  
 Press "Oscillating cleansing/ Pulsating cleansing" button about 10 seconds or longer

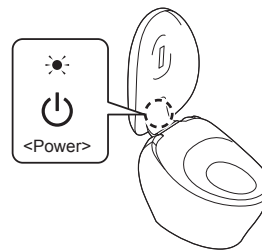

### To turn the power "OFF"

- Perform the same operation as Step 2 above.  
• The "POWER" LED goes off.

### 3. Open the shutoff valve

- 1** Remove the shutoff valve cover.

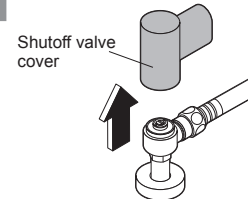

- 2** Fully open the shutoff valve.

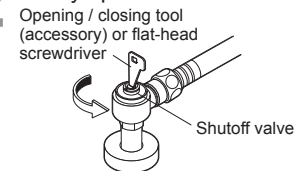

- 3** Install the shutoff valve cover.

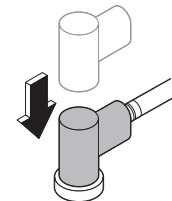



# Basic Operations How the Automatic Functions Work

"ewater+"<sup>\*1</sup> is used automatically to clean the wand and bowl unit.

•Operation under the initial settings is described below. The functions can also be used after changing the settings. (Page 28 - 37)

As you approach <sup>*2</sup>	As you sit <sup>*3</sup>	As you stand up	As you move away
<b>Auto open/close (lid)</b>	<b>Deodorizer</b>	<b>Auto power deodorizer</b>	<b>Auto flushing</b>
 <b>The toilet lid opens</b>  [When standing and using] ..... Open the toilet seat with the remote control.  ● The Bowl light lights up <b>Auto bowl CLEAN</b>   <b>Pre-mist</b> A mist is sprayed inside the bowl unit to make it more difficult for dirt to adhere	 <b>The deodorizer starts</b>  Removing odors inside the bowl unit	(About 10 seconds after standing up)  <b>The power deodorizer starts</b>  It stops after about 60 seconds <b>Auto flushing</b>   <b>The toilet flushes</b>  When sitting for around 6 to 30 seconds: "Light flush" When sitting for around 30 seconds or more: "Full flush"  Only when the cleansing functions are used. (About 25 seconds after standing up) ● The Bowl light lights up <b>Auto wand CLEAN</b>   The wand extends and is cleaned by "ewater+" <sup>*1</sup> that comes out from the base of the wand	[When used while standing] ..... (About 3 seconds after moving away from the bowl unit by about 40 cm or more.) <b>Auto flushing</b>   <b>The toilet flushes</b>  "Light flush"  (About 90 seconds after moving away from the bowl unit by about 40 cm or more.) <b>Auto open/close (lid)</b>   <b>The toilet lid and toilet seat close</b>  <b>Instant heated seat</b>   <b>Returns to the standby temperature</b>
<b>Instant heated seat</b>	<b>Instant heated seat</b>		<b>Instant heated seat</b>
 <b>Warming starts from the standby temperature</b>	 <b>Warms to the set temperature</b>		 <b>Returns to the standby temperature</b>
<b>Soft light</b>		<b>Auto bowl CLEAN</b>	
Lighting up the inside of the bathroom with a soft light It lights up as you approach the bowl unit and goes off about 90 seconds after standing up. ⇒"Soft light" ON/OFF (Page 36)		(After about 90 seconds) ● The Bowl light lights up <b>Auto bowl CLEAN</b>   <b>After-mist</b> "ewater+" <sup>*1</sup> mist is sprayed on the bowl unit <b>Auto open/close (lid)</b>   <b>The toilet lid closes</b>  <b>Photocatalyst cleaning<sup>*4</sup></b>  <b>The UV lamp lights up</b> (For about 1 hour)	

**Soft light**

Lighting up the inside of the bathroom with a soft light  
It lights up as you approach the bowl unit and goes off about 90 seconds after standing up.  
⇒"Soft light" ON/OFF (Page 36)

**CLEAN indicator**

Lights to show that the "Auto bowl CLEAN," "Deodorizer," and "Auto wand CLEAN" functions are operating.

light up (Or) lights up in a cycle

(Lights only when the toilet seat is not in-use)  
⇒"CLEAN indicator" ON/OFF (Page 37)

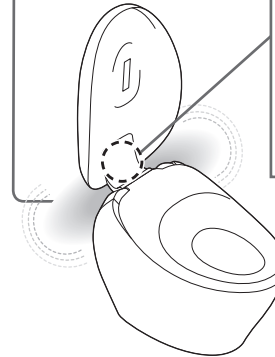

\*1 What is meant by "ewater+" ?

This water containing hypochlorous acid generated from chloride ions in tap water, is widely used for cleaning and disinfecting items such as food, utensils and baby bottles.

- Well water may not deliver the required effect. (Because the level of chloride ions is low.)
- "ewater+" helps to minimize dirty surfaces, but does not make cleaning unnecessary.
- The effect and duration vary depending on the usage environment and conditions.

**As you leave**



(After about 90 seconds)  
● The Bowl light lights up  
**Auto bowl CLEAN**

**After-mist**  
 "ewater+"<sup>\*1</sup> mist is sprayed on the bowl unit

**Auto open/close (lid)**

**The toilet lid closes**

**Photocatalyst cleaning<sup>\*4</sup>**

**The UV lamp lights up**  
(For about 1 hour)

\*2 Detection by the body sensor may be difficult when the toilet is used by someone small, such as a child.

\*3 Water comes out from the area around the wand for several seconds while water is warmed up.

\*4 Other than the CS900\*\*\*

# Basic Operations Using the Remote Control

Press a button on the remote control; a beep sound when the top unit receives the signal.

**Cleansing<sup>\*1</sup>**

- "Rear cleansing" Cleanses your rear.
- "Rear soft cleansing" Cleanses your rear with soft embracing water flow.
- "Front cleansing" Serves as a bidet for ladies.
- "Wide front cleansing" Gently cleanses a wide area.

**Drying<sup>\*1</sup>**

- "Drying" Dries your rear.

**Stopping**

- "Stopping" Stops the operation.



**■ Wand CLEAN**

Cleans the wand with "ewater+"

- The wand can be automatically cleaned when you use the cleansing functions (Rear cleansing, Front cleansing, etc.). (Page 16)

● Functions that operate when a button is pressed during "Rear cleansing", "Rear soft cleansing", "Front cleansing" or "Wide front cleansing".

**■ Water pressure adjustment**

You can select from 5 levels of water pressure.  
([-] Softer, [+] Stronger)

- When you press the cleansing buttons (Rear, Rear soft, Front, Wide front), the position returns to the standard position (3rd position).

If you do not want to return the wand to the standard position. (Page 41)

**■ Wand position adjustment**

You can select from 5 levels of wand position between the front and the rear, using the [▲] and [▼] buttons.

- When you press the cleansing buttons (Rear, Rear soft, Front, Wide front), the position returns to the standard position (3rd position).

If you do not want to return the wand to the standard position. (Page 41)

**"Oscillating cleansing"**

The wand moves back and forth to cleanse your rear thoroughly.

**"Pulsating cleansing"**

Cleanses with the water pressure pulsating between soft and strong.

The cleansing setting changes each time the button is pressed



**Note** ● Sitting back on the toilet seat makes it easier to adjust the wand position and to reduce splashing.

**Flushing**

- "Full flush" Performs a full flush.
  - Up to 10 m of toilet paper (single)
- "Light flush" Performs a light flush.
  - Up to 3m of toilet paper (single)

**Opening and closing**

- "Opening and closing the toilet seat" Opens and closes the toilet seat.

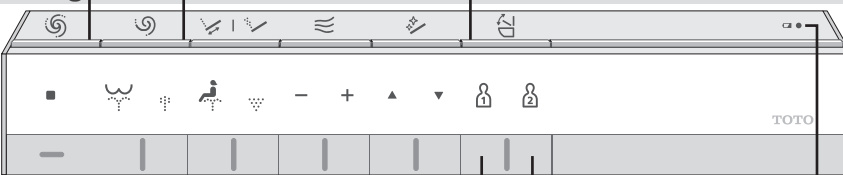

**■ Personal setting lock**

You can store your preferred "Wand position," "Water pressure," and "Warm water temperature" settings.

- To store a setting  
While cleansing is in progress, set your preferred "Wand position," "Water pressure," and "Warm water temperature," and then press and hold 1 or 2 for 2 seconds or longer.
- To use  
Press 1 or 2, and then press the button for the cleansing you want to use.

**Low battery warning LED**  
(Page 57)



**Remote control back side**

**Display screen**

- The display goes out when no buttons on the remote control are pressed for about 60 seconds or more.

**"Menu, Return" button**  
(Page 20)

- Adjust settings
- Return to the previous menu

**"Temperature adjustment" button**  
(Page 22)

- Adjust temperatures

**"Power ON/OFF" button**

- Pressing it about 3 seconds or longer turns the power on/off.
- If the remote control is locked to prevent theft (Page 15, Procedure 2-2)

\*1 This cannot be used if the seat sensor is not working. Sit so your skin is in direct contact with the seat sensor (page 9).

# Basic Operations

## About the Menu Screen

This section is an overview of the settings that can be configured with the remote control.

● See the corresponding pages for the detailed descriptions.



Remote control back side

Adjust temperatures  
(Page 22)

Number of items  
on display

### 1 Press

• The display screen changes.

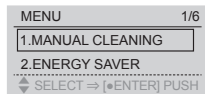

### 2 Set the item from the display screen.

When you move the buttons (Up/Down), the frame of the item moves.

When you move the buttons (Right/Left), you can select the setting.

When you press the button, the item is entered.

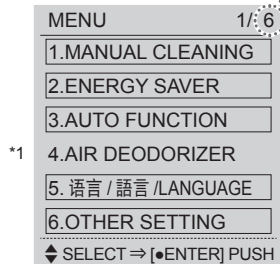

\*1

SELECT => [ENTER] PUSH

The next step is shown at the bottom of the display screen.

You can set as desired

If you want to return to the previous item, press the button.

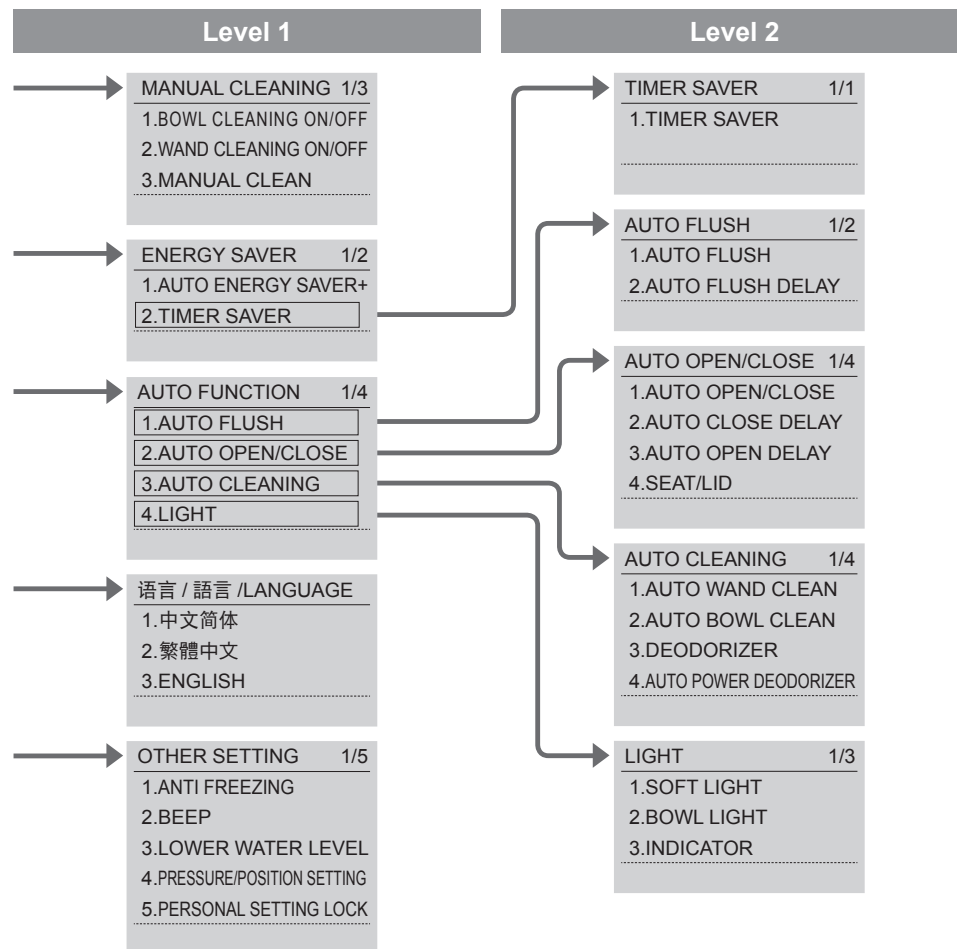

\*1 [AIR DEODORIZER] appears but this feature is not available on this product.

# Temperature adjustment Warm Water, Toilet Seat, Drying

Five different temperature levels from high to low and "OFF" can be set.

## Remote control back side

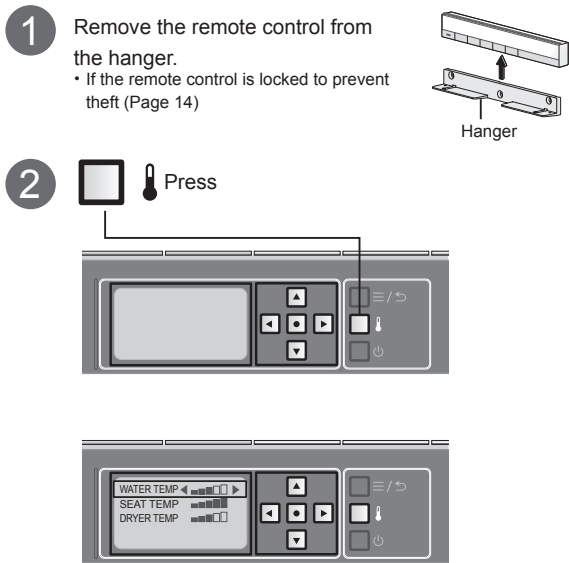
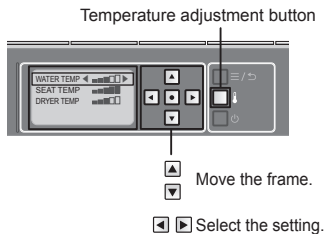

To the next page

### CAUTION

- During setting, the display goes out when no button is pressed within about 60 seconds.
- If you fail to complete the setting, redo from the step 2.

## Warm water temperature

- 3 Select [WATER TEMP]

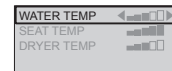

- 4 Select the temperature level.

<Settings complete>

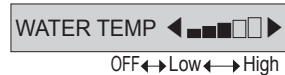

Press until [OFF] appears.<sup>\*1</sup>

## Toilet seat temperature

- 3 Select [SEAT TEMP]

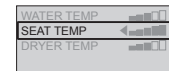

- 4 Select the temperature level.

<Settings complete>

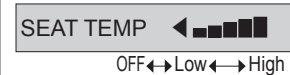

Press until [OFF] appears.

- When "OFF" is set, the "Seat" LED on the main display will go off.

## Drying air temperature

- 3 Select [DRYER TEMP]

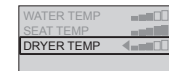

- 4 Select the temperature level.

<Settings complete>

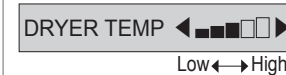

- The "Drying" cannot be turned "OFF".

- 5 Mount the remote control in the hanger.
  - If the remote control is locked to prevent theft (Page 14)

\*1 To prevent condensation, the water temperature does not drop below 20°C even when set to "OFF".

● If adjusting the temperature does not warm up the toilet seat → Is "Energy saver" set to "ON"? (Page 24)

# Energy Saver Features Type

"Auto energy saver+" or "Timer energy saver" can be selected.

You can save energy by turning the toilet seat heater "OFF".

● "Auto energy saver+" takes about 10 days to detect time periods in which the toilet seat is never used.

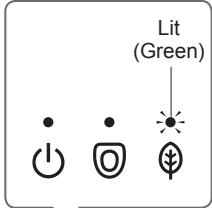
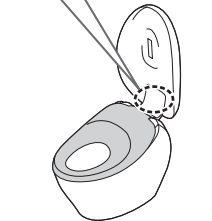
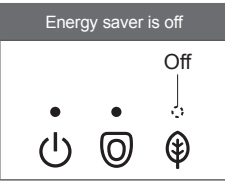



Type	Situation	Energy saver is on	
		Main display	
<b>Auto energy saver+</b>	<p>You want the NEOREST to save energy automatically.</p> <p>The NEOREST detects time periods with no use and turns the toilet seat heater OFF automatically.</p>		→
<b>Timer energy saver</b>	<p>You want to save energy only for the preset duration of time. (6 hours, 9 hours)</p> <p>Once the time is set, the toilet seat heater turn off automatically during the set time period every day.</p>		→
<b>Timer energy saver + Auto energy saver+</b>	<p>You want to save a lot of energy with auto energy saver and timer energy saver.</p> <p>When <b>both</b> "timer energy saver" and "Auto energy saver+" are <b>set</b>, "Auto energy saver+" operates when "timer energy saver" is not operating.</p>	<p>Energy saver is off</p> 	→

● Even if the energy saver feature is on (i.e., the toilet seat heater is "OFF"), the seat temporarily becomes warm when approaching the bowl unit or when sitting on the toilet seat.

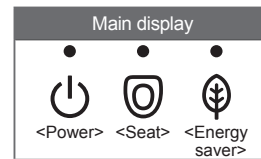
(It takes about 60 seconds to reach the setting temperature.)

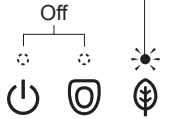
(The LED indication on the main display returns to the state for when the energy saver is on.)

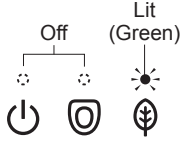

When energy saver is in operation		AM		PM		
Toilet seat heater		0	4	8	5	0
		Example: Not used from 0 am to 4 am				
		Standby temperature <sup>*1</sup>				
		OFF <sup>*2</sup>				
		Example: Set from 8 am to 5 pm				
		Standby temperature <sup>*1</sup>		Standby temperature <sup>*1</sup>		
		OFF <sup>*2</sup>				
<p>● During "Auto energy saver+": Same LED indication as "Auto energy saver+" (see above)</p> <p>● During "Timer energy saver+": Same LED indication as "Timer energy saver" (see above)</p>		Example: when "Timer energy saver" and "Auto energy saver+" are used together				
		Standby temperature <sup>*1</sup>		Standby temperature <sup>*1</sup>		
		OFF <sup>*2</sup>		OFF <sup>*2</sup>		

\*1 The time period when the toilet seat heater is set to a "standby temperature".

\*2 The time period when the toilet seat heater is set to a "OFF".

To set energy saver Page 26 and 27

# Energy Saver Features

## How to Set

Set the "Timer energy saver" at the time you want to start it.

### Remote control back side

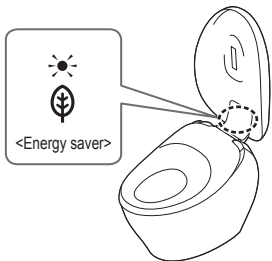
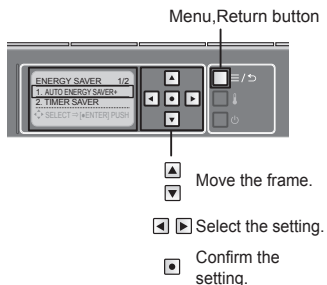

When energy saver is set, the "Energy saver" LED (green) lights up.

### CAUTION

- During setting, the display goes out when no button is pressed within about 60 seconds.
- If you fail to complete the setting, redo from the step 1.

## Auto energy saver+

- Press
- Select [ENERGY SAVER]
- Select [AUTO ENERGY SAVER+]
- Select [ON] or [OFF]

(To return → )

## Timer energy saver

- Press
- Select [TIMER SAVER]
- Select [TIMER SAVER]
- Select [6H], [9H] or [OFF]

(To return → )

- To change the timer energy saver time:  
→ Set the timer energy saver again at the time you want to start it.

## Turning off energy saver

Select [OFF] in step 4 in each procedure on the left (Example: "Timer energy saver")

Press

(To return → )

# Various Usage Setting List

Setting Types		Available Settings • Bold: Initial settings	
Auto functions	Auto flushing	Auto flushing	ON/OFF
		Auto flush delay	5seconds/ <b>10seconds</b> / 15seconds
	Auto open/close (lid)	Auto open/close (lid)	ON/OFF
		Auto close delay	25seconds/ <b>90seconds</b>
		Auto open delay	<b>15seconds</b> /30seconds/ 90seconds
		Seat/lid	Lid/Seat·Lid
	Auto cleaning	Auto wand CLEAN	ON/OFF
		Auto bowl CLEAN	ON/OFF
		Deodorizer	ON/OFF
		Auto power deodorizer	ON/OFF
	Light	Soft light	ON/OFF
		Bowl light	ON/OFF
		CLEAN indicator	ON/OFF
Language settings		Simplified Chinese/ Traditional Chinese/English	
Other settings	Anti freezing	ON/OFF	
	Beep sound	ON/OFF	
	Lower water level	-	
	Pressure/position setting	ON/OFF	
	Personal setting lock	ON/OFF	

**CAUTION** • During setting, the display goes out when no button is pressed within about 60 seconds. If you fail to complete the setting, redo from the step 1.

Setting Contents	Setting Ref. Page
• Set whether or not to <b>clean the bowl unit automatically</b>	Page 30
• Change the <b>amount of time before the toilet flushes automatically</b>	
• Set whether or not to <b>open and close the toilet lid automatically</b>	Page 32, 33
• Change the <b>amount of time before the lid/seat closes automatically</b>	
• Change the <b>amount of time after which the lid/seat opens automatically upon closing it by hand</b>	
• <b>Automatically open and close the toilet lid only/Automatically open and close the toilet seat and toilet lid</b>	
• Set whether or not to <b>clean the wand automatically</b>	Page 34, 35
• Set whether or not to <b>spray mist in the bowl unit automatically</b>	
• Set whether or not to <b>deodorize automatically after sitting on the toilet seat</b>	
• Set whether or not to <b>power deodorize automatically after standing up</b>	
• Set whether or not to <b>use the soft light</b>	Page 36, 37
• Set whether or not to <b>use the light inside the bowl unit</b>	
• Set whether or not to <b>light up the CLEAN indicator</b>	
• <b>Select the language</b> displayed on the back of remote control	Page 38
• Set whether or not to <b>run the water for the bowl unit and top unit automatically at a fixed interval in order to prevent freezing</b> (dynamic mode → Page 58)	Page 40, 41
• Set whether or not to <b>make a beep sound</b>	
• Lower the <b>bowl unit water level</b>	
• Set whether or not to <b>keep your favorite pressure and position settings</b>	
• Set whether or not to <b>use the personal setting lock</b>	

# Various Usage Auto Functions

## Remote control back side

Items set on this display

1. AUTO FLUSH  
"Auto flushing"
2. AUTO FLUSH DELAY  
"Auto flush delay"

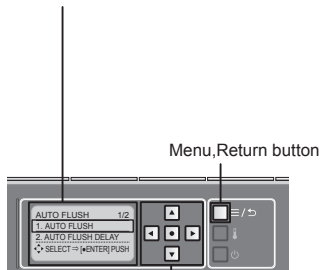

- Move the frame.
- Select the setting.
- Confirm the setting.

\*1 This operation is not available when the "Auto flushing" is "OFF".

### Auto flushing

Set whether or not to clean the bowl unit automatically

## Auto flushing

Change the amount of time before the toilet flushes automatically \*1

## Auto flush delay \*1

**1** Press

**2** Select  
 [AUTO FUNCTION]

**3** Select  
 [AUTO FLUSH]

**4** Select  
 [AUTO FLUSH]

**4** Select  
 [AUTO FLUSH DELAY]

**5** Select [ON] or [OFF]

Press

AUTO FLUSH OFF

(To return → )

**5** Select [5S], [10S], or [15S]

Press

AUTO FLUSH DELAY 15S

(To return → )





# Various Usage Auto Functions

## Remote control back side

Items set on this display

1. AUTO OPEN/CLOSE  
"Auto open/close (lid)"
2. AUTO CLOSE DELAY  
"Auto close delay"
3. AUTO OPEN DELAY  
"Auto open delay"
4. SEAT/LID  
"Seat/lid"

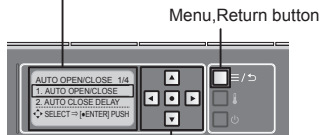

- Move the frame.
- Select the setting.
- Confirm the setting.

\*1 When the "Auto open/close (lid)" is set to "OFF", UV lamp does not work while the lid is open. Please close with your hands. (Other than the CS900\*\*\*)

\*2 This operation is not available when the "Auto open/close (lid)" is "OFF".

\*3 When set to "25seconds", the lid/seat does not open automatically for about 15 seconds after closing automatically.

\*4 When the "Seat/Lid" are set to open automatically, pre-mist is not sprayed.

Auto open/close (lid)

Set whether or not to open and close the toilet lid automatically

### Auto open/close (lid)

**1** Press

**2** Select  
 [AUTO FUNCTION]

**3** Select  
 [AUTO OPEN/CLOSE]

**4** Select  
 [AUTO OPEN/CLOSE]

**5** Select [ON] or [OFF]<sup>\*1</sup>

Press

AUTO OPEN/CLOSE OFF

(To return → )

Auto close delay (lid)

Change the amount of time before the lid/seat closes automatically

### Auto close delay \*2

**1** Press

**2** Select  
 [AUTO FUNCTION]

**3** Select  
 [AUTO OPEN/CLOSE]

**4** Select  
 [AUTO CLOSE DELAY]

**5** Select [25S] or [90S]<sup>\*3</sup>

Press

AUTO CLOSE DELAY 25S

(To return → )

Auto open/close (lid)

Change the time period till automatic opening (after closing by hand.)

### Auto open delay \*2

**1** Press

**2** Select  
 [AUTO FUNCTION]

**3** Select  
 [AUTO OPEN/CLOSE]

**4** Select  
 [AUTO OPEN DELAY]

**5** Select [15S], [30S], or [90S]

Press

AUTO OPEN DELAY 30S

(To return → )

Auto open/close (lid)

Automatically open and close the toilet lid only/Automatically open and close the toilet seat and toilet lid

### Seat/lid \*2

**1** Press

**2** Select  
 [AUTO FUNCTION]

**3** Select  
 [AUTO OPEN/CLOSE]

**4** Select  
 [SEAT/LID]

**5** Select [LID] or [SEAT·LID]<sup>\*4</sup>

Press

AUTO OPEN/CLOSE SEAT·LID

(To return → )

# Various Usage Auto Functions

## Remote control back side

Items set on this display

1. AUTO WAND CLEAN  
"Auto wand CLEAN"
2. AUTO BOWL CLEAN  
"Auto bowl CLEAN"
3. DEODORIZER  
"Deodorizer"
4. AUTO POWER DEODORIZER  
"Auto power deodorizer"

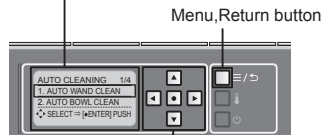

- Move the frame.
- Select the setting.
- Confirm the setting.

## Auto cleaning

Set whether or not to clean the wand automatically  
**Auto wand CLEAN**

**1** Press

MENU	1/6
1. MANUAL CLEANING	
2. ENERGY SAVER	
3. AUTO FUNCTION	
SELECT ⇒ [ENTER] PUSH	

**2** Select  
 [AUTO FUNCTION] → Press

MENU	3/6
2. ENERGY SAVER	
3. AUTO FUNCTION	
SELECT ⇒ [ENTER] PUSH	

**3** Select  
 [AUTO CLEANING] → Press

AUTO FUNCTION	3/4
2. AUTO OPEN/CLOSE	
3. AUTO CLEANING	
SELECT ⇒ [ENTER] PUSH	

**4** Select  
 [AUTO WAND CLEAN]

AUTO CLEANING	1/4
1. AUTO WAND CLEAN	ON
2. AUTO BOWL CLEAN	ON
SELECT ⇒ [ENTER] PUSH	

**5** Select [ON] or [OFF]

AUTO CLEANING	1/4
1. AUTO WAND CLEAN	OFF
2. AUTO BOWL CLEAN	ON
SELECT ⇒ [ENTER] PUSH	

Press

AUTO WAND CLEAN OFF

(To return → )

Set whether or not to spray mist in the bowl unit automatically  
**Auto bowl CLEAN**

**1** Press

MENU	1/6
1. MANUAL CLEANING	
2. ENERGY SAVER	
3. AUTO FUNCTION	
SELECT ⇒ [ENTER] PUSH	

**2** Select  
 [AUTO FUNCTION] → Press

MENU	3/6
2. ENERGY SAVER	
3. AUTO FUNCTION	
SELECT ⇒ [ENTER] PUSH	

**3** Select  
 [AUTO CLEANING] → Press

AUTO FUNCTION	3/4
2. AUTO OPEN/CLOSE	
3. AUTO CLEANING	
SELECT ⇒ [ENTER] PUSH	

**4** Select  
 [AUTO BOWL CLEAN]

AUTO CLEANING	2/4
1. AUTO WAND CLEAN	ON
2. AUTO BOWL CLEAN	ON
SELECT ⇒ [ENTER] PUSH	

**5** Select [ON] or [OFF]

AUTO CLEANING	2/4
1. AUTO WAND CLEAN	ON
2. AUTO BOWL CLEAN	OFF
SELECT ⇒ [ENTER] PUSH	

Press

AUTO BOWL CLEAN OFF

(To return → )

## Auto cleaning

Set whether or not to deodorize automatically after sitting on the toilet seat  
**Deodorizer**

**1** Press

MENU	1/6
1. MANUAL CLEANING	
2. ENERGY SAVER	
3. AUTO FUNCTION	
SELECT ⇒ [ENTER] PUSH	

**2** Select  
 [AUTO FUNCTION] → Press

MENU	3/6
2. ENERGY SAVER	
3. AUTO FUNCTION	
SELECT ⇒ [ENTER] PUSH	

**3** Select  
 [AUTO CLEANING] → Press

AUTO FUNCTION	3/4
2. AUTO OPEN/CLOSE	
3. AUTO CLEANING	
SELECT ⇒ [ENTER] PUSH	

**4** Select  
 [DEODORIZER]

AUTO CLEANING	3/4
2. AUTO BOWL CLEAN	ON
3. DEODORIZER	ON
SELECT ⇒ [ENTER] PUSH	

**5** Select [ON] or [OFF]

AUTO CLEANING	3/4
2. AUTO BOWL CLEAN	ON
3. DEODORIZER	OFF
SELECT ⇒ [ENTER] PUSH	

Press

DEODORIZER OFF

(To return → )

Set whether or not to power deodorize automatically after standing up  
**Auto power deodorizer**

**1** Press

MENU	1/6
1. MANUAL CLEANING	
2. ENERGY SAVER	
3. AUTO FUNCTION	
SELECT ⇒ [ENTER] PUSH	

**2** Select  
 [AUTO FUNCTION] → Press

MENU	3/6
2. ENERGY SAVER	
3. AUTO FUNCTION	
SELECT ⇒ [ENTER] PUSH	

**3** Select  
 [AUTO CLEANING] → Press

AUTO FUNCTION	3/4
2. AUTO OPEN/CLOSE	
3. AUTO CLEANING	
SELECT ⇒ [ENTER] PUSH	

**4** Select  
 [AUTO POWER DEODORIZER]

AUTO CLEANING	4/4
4. AUTO POWER DEODORIZER	ON
SELECT ⇒ [ENTER] PUSH	

**5** Select [ON] or [OFF]

AUTO CLEANING	4/4
4. AUTO POWER DEODORIZER	OFF
SELECT ⇒ [ENTER] PUSH	

Press

AUTO POWER DEODORIZER OFF

(To return → )

# Various Usage Auto Functions

## Remote control back side

Items set on this display

1. SOFT LIGHT  
"Soft light"
2. BOWL LIGHT  
"Bowl light"
3. INDICATOR  
"CLEAN indicator"

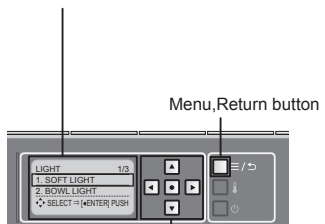

- Move the frame.
- Select the setting.
- Confirm the setting.

### Soft light

Set whether or not to use the soft light

- 1 Press
- 2 Select  
 [AUTO FUNCTION]
- 3 Select  
 [LIGHT]
- 4 Select  
 [SOFT LIGHT]
- 5 Select [ON] or [OFF]

### Bowl light

Set whether or not to use the light inside the bowl unit

- 1 Press
- 2 Select  
 [AUTO FUNCTION]
- 3 Select  
 [LIGHT]
- 4 Select  
 [BOWL LIGHT]
- 5 Select [ON] or [OFF]

SOFT LIGHT OFF

(To return → )

BOWL LIGHT OFF

(To return → )

Light

Set whether or not to light up the CLEAN indicator

### CLEAN indicator

- 1 Press
- 2 Select  
 [AUTO FUNCTION]
- 3 Select  
 [LIGHT]
- 4 Select  
 [INDICATOR]
- 5 Select [ON] or [OFF]

INDICATOR OFF

(To return → )

# Various Usage Language Settings

## Remote control back side

Items set on this display

1. 中文简体  
"Simplified Chinese"
2. 繁體中文  
"Traditional Chinese"
3. ENGLISH  
"English"

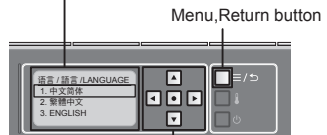

- Move the frame.
- Move the frame.
- Confirm the setting.

Select the language displayed on the back of remote control

## Language settings

**1** Press

MENU	1/6
1. MANUAL CLEANING	
2. ENERGY SAVER	
SELECT ⇒ [ENTER] PUSH	

**2** Select  
 [语言 / 語言 / LANGUAGE]

MENU	5/6
4. AIR DEODORIZER	
5. 语言 / 語言 / LANGUAGE	
SELECT ⇒ [ENTER] PUSH	

Press

**3** Select [中文简体],  
 [繁體中文], or [ENGLISH]

语言 / 語言 / LANGUAGE	
1. 中文简体	
2. 繁體中文	
3. ENGLISH	

Press

LANGUAGE ENGLISH
------------------

(To return → )



### Remote control back side

Items set on this display

1. ANTI FREEZING  
"Anti freezing"
2. BEEP  
"Beep sound"
3. LOWER WATER LEVEL  
"Lower water level"
4. PRESSURE/POSITION SETTING  
"Pressure/position setting"
5. PERSONAL SETTING LOCK  
"Personal setting lock"

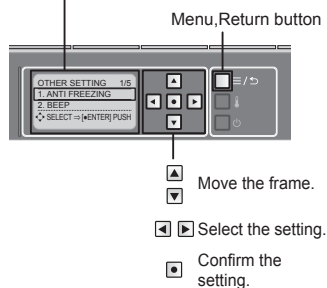

### Anti freezing

Set whether or not to run the water for the bowl unit and top unit automatically at a fixed interval in order to prevent freezing

1  ≡/↵ Press

2  Select  
 [OTHER SETTING] →  Press

3  Select  
 [ANTI FREEZING]

4   Select [ON] or [OFF]  
<For setting to [ON]>  
When the time is set, the bowl unit is cleaned in about 10 minutes intervals to prevent freezing.

Press

Press

(To return →  ≡/↵ )

### Beep sound

Set whether or not to make a beep sound

3  Select  
 [BEEP]

4   Select [ON] or [OFF]

Press

(To return →  ≡/↵ )

### Lower water level

Lower the bowl unit water level (For reducing water rebound, collecting a stool sample, etc.)

1  ≡/↵ Press

2  Select  
 [OTHER SETTING] →  Press

3  Select  
 [LOWER WATER LEVEL]

Press

The water in the bowl unit flows and accumulates at a low water level.

Note

- The water level returns normal when the toilet is flushed. Please set this function each time you want to lower the water level.

### Pressure/position setting

Set whether or not to keep your favorite pressure and position settings

1  ≡/↵ Press

2  Select  
 [OTHER SETTING] →  Press

3  Select  
 [PRESSURE/POSITION SETTING]

4   Select [ON] or [OFF]

Press

(To return →  ≡/↵ )

### Personal setting lock

Set whether or not to use the personal setting lock

1  ≡/↵ Press

2  Select  
 [OTHER SETTING] →  Press

3  Select  
 [PERSONAL SETTING LOCK]

4   Select [ON] or [OFF]

Press

(To return →  ≡/↵ )

# Maintenance

**⚠ WARNING**

Always switch the breaker on the distribution board to **OFF** before cleaning, maintenance, or inspection. (Failure to do so may cause electric shock or malfunction, resulting in a breakdown.)

For safety, turn off the breaker on the distribution board before cleaning or maintenance.\*1

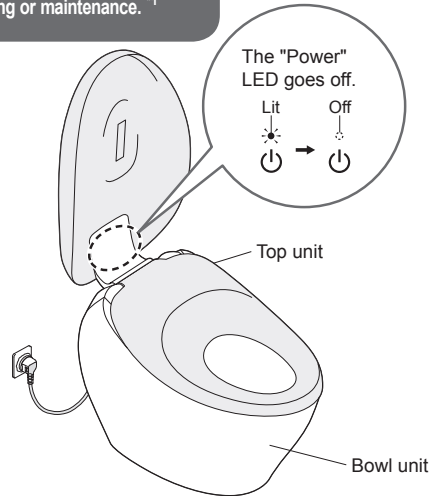

**Do not use a dry cloth or toilet paper on plastic parts.**  
(May cause damage.)

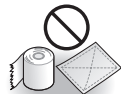

\*1 Except when using "Wand cleaning" or "Bowl unit cleaning".  
\*1 After the distribution board breaker is switched to ON, the toilet lid does not open automatically for about 10 seconds (because it is preparing for operation). Open and close by hand.

## Top Unit

### Top Unit (Approximately daily)



Soft cloth soaked in water

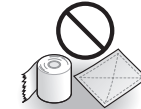

· Toilet paper  
· Dry cloth  
· Nylon scrubbing brush  
(May cause damage.)

- 1 Switch the breaker on the distribution board to OFF.
- 2 Wipe with a soft cloth that has been soaked in water and wrung-out thoroughly.

**■ For heavy dirt**

- Wipe with a soft cloth soaked in diluted, neutral kitchen detergent, and then wipe with a soft cloth soaked in water.



· Neutral kitchen detergent



· Paint thinner  
· Benzene  
· Powdered cleanser

- 3 Switch the breaker on the distribution board to ON.  
· The "Power" LED lights up.

**Attention!**

- The NEOREST NX is an electric appliance. Be careful not to let water seep inside or leave detergent in the gap between the top unit and bowl unit.  
(May damage plastic parts or cause a malfunction.)
- When using a toilet cleaner to clean the toilet, rinse it off within 3 minutes and leave the toilet seat and toilet lid open.  
· Wipe off any cleaner that remains on the bowl unit.  
(If vapor from a toilet cleaner enters the top unit, it may cause a malfunction.)
- Do not push or pull the covers around the wand with undue force.  
(May cause damage or malfunction.)
- Wipe the back surface of the toilet seat and the toilet seat cushions with a soft cloth tightly wrung out with water.  
(Otherwise adhesion of dirt may result in discoloration.)
- Please wipe any water droplets so that none remain on the toilet seat.  
(Failure to do so may cause malfunction of the seat sensor or the  Flush button on the upper right corner of the toilet seat.)

## Bowl Unit (Approximately daily)



- Toilet brush
- Neutral toilet detergent



- Strongly acidic cleaners or strong alkaline cleaners
- Cleaners containing abrasive compounds
- Fluoride-based detergent (Containing hydrogen fluoride or ammonium fluoride)
- Wire brush
- Abrasive nylon scrubbing brush

**1** Switch the breaker on the distribution board to OFF.

**2** Clean with a toilet brush or a similar tool.

■ **The water level in the bowl unit can be lowered to perform cleaning or maintenance.**

(Switch the breaker on the distribution board to ON.)

<"Bowl unit cleaning"> Operate with the buttons on the back side of the remote control.

- ① Press
- ② Select [MANUAL CLEANING] → Press
- ③ Select [BOWL CLEANING ON/OFF] → Press

• The water in the bowl unit flows, and then drains. After that, the water level drops for about 50 seconds.

**Clean inside the bowl unit.**

↓  
• The water in the bowl unit drains, and then returns to its original level.

● **To stop part way through, press ■ ("Stopping" button) on the front side of the remote control.**

**3** Switch the breaker on the distribution board to ON.

■ **"ewater+" mist can be sprayed to finish cleaning or maintenance.**

(It cannot be used when the wand is out or when you are sitting on the toilet seat.)

<"Manual CLEAN"> Operate with the buttons on the back side of the remote control.

- ① Press
- ② Select [MANUAL CLEANING] → Press
- ③ Select [MANUAL CLEAN] → Press

("ewater+" mist is sprayed on the bowl unit.)

## Bowl Unit (Approximately daily) (Continued)

■ **If the bowl unit is clogged**

- Using plunger or similar, provide 10 cm or more clearance between the top of the bowl unit and the water surface. Use commercially available tools that are made for unclogging the bowl unit. (May cause overflow of dirty water and water damage.)



■ **If the floor is dirty**

- Clean it with a well wrung cloth. (Not cleaning the floor may cause stains or corrosion.)
- Sitting is recommended to reduce splashing caused by standing and urinating.

### Attention!

- Be careful not to expose the top unit or the gap between it and the bowl unit to water. (May cause water overflow into the room.)
- Do not use any water repellent, stain-proofing cleaner or surface coating agent. These products would not damage the porcelain surface, but they may cover the porcelain surface and reduce the effect of the built-in stain prevention technology.

## Bowl Unit \*1 (Approximately once a month)









- To preserve the performance of the photocatalyst cleaning, clean the toilet bowl surface with a toilet brush, etc. using commercially available hydrochloric acid-based or inorganic acid-based detergent.

\*1 Other than the CS900\*\*\*

## Wand (Approximately once a month) <If you notice dirt (Wand cleaning)>

### 1 Extend the wand.

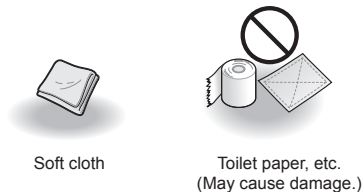

#### To operate from the back of remote control

- ①    Press
- ②  Select [MANUAL CLEANING] →   Press
- ③  Select [WAND CLEANING ON/OFF] →   Press



#### To operate from the front of remote control

\*Recommended if the remote control is locked to prevent theft.

- ①  Press "Stopping" button about 10 seconds or longer.
- ②  Press "Front cleansing" button about 3 seconds or longer.

- The wand extends and water sprays out for cleaning.
- The wand automatically retracts after about 5 minutes.

### 2 Wipe with a soft, wet cloth.

- Do not pull, push or press the wand with excessive force.  
(May cause malfunction or damage.)

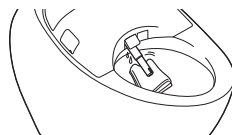

### 3 Press "Stopping" button on the front side of the remote control.

- The wand retracts.

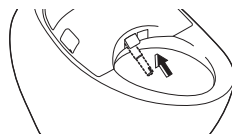

## Deodorizing Filter (Approximately once a month)

### 1 Switch the breaker on the distribution board to OFF.

### 2 Hold the tab on the deodorizing filter and pull it forward.

- Do not pull with undue force.  
(May cause damage or malfunction.)
- \* The deodorizing filter cannot be removed completely.

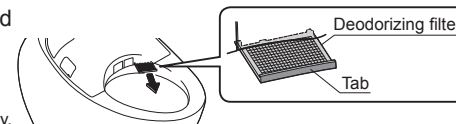

### 3 Clean with a tool such as a toothbrush.

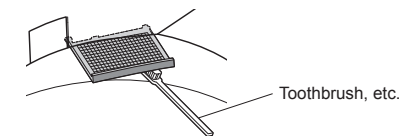

### 4 Push in the deodorizing filter.

- Push firmly until it is in the original position.

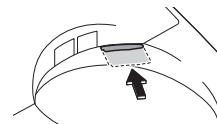

### 5 Switch the breaker on the distribution board to ON.

- The "Power" LED lights up.



Water Filter **Drain Valve** (Approximately once every 6 months) <If you think the water pressure has weakened>

- 1 Remove the shutoff valve cover, and then close the shutoff valve.
  - The water supply stops.

### CAUTION



**Do not remove the water filter drain valve while the shutoff valve is open.**

(Otherwise, water may leak out.)

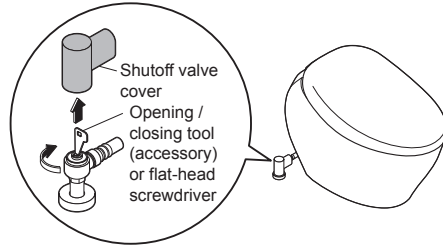

- 2 Press "Wand CLEAN" button.
  - Opens the wand cover.
  - (Release the pressure from the water supply pipe.)

- 3 Switch the breaker on the distribution board to OFF.

- 4 Remove the cover on the left side of the main unit and water filter drain valve.
  - Insert the flat-head screwdriver firmly in the hook. (May cause damage.)
  - Loosen the water filter drain valve with a flat-head screwdriver and then pull it.

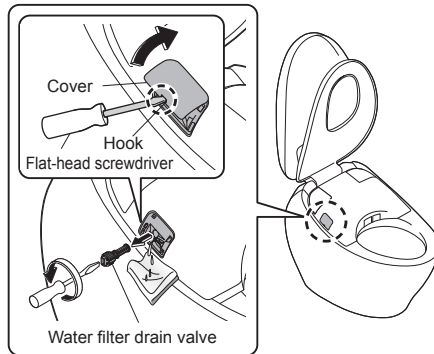

Water Filter **Drain Valve** (Approximately once every 6 months) <If you think the water pressure has weakened> (Continued)

- 5 Clean with a tool such as a toothbrush.
  - Also, remove any dust from inside the hole of the water filter drain valve.

- 6 Reinstall the water filter drain valve and cover.
  - Insert the water filter drain valve and use a flat-head screwdriver to tighten it securely.

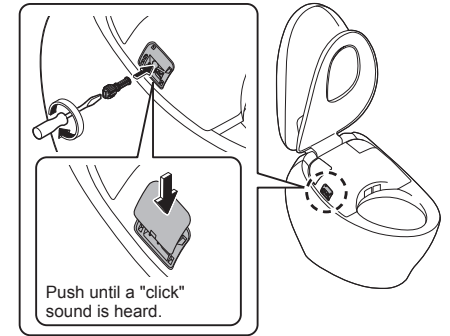

- 7 Switch the breaker on the distribution board to ON.
  - The "Power" LED lights up.

- 8 Open the shutoff valve, and then install the shutoff valve cover.

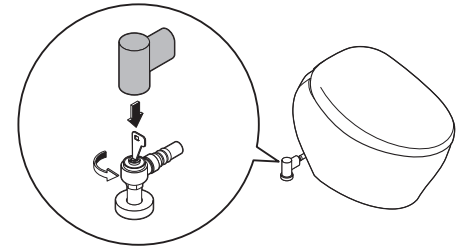



## Water Filter (Bowl Unit) (Approximately once every 6 months)

- 1** Remove the shutoff valve cover, and then close the shutoff valve.
- The water supply stops.

### **CAUTION**

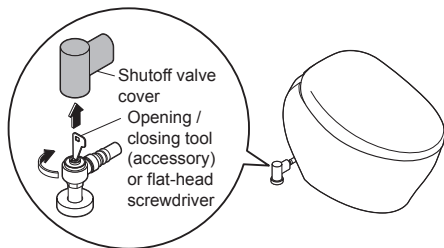
 **Do not remove the water filter while the shutoff valve is open.**  
(Otherwise, water may leak out.)



- 2**  Press "Wand CLEAN" button.
- Opens the wand cover.
  - (Release the pressure from the water supply pipe.)

- 3** Switch the breaker on the distribution board to OFF.

- 4** Loosen the cap of the water filter to remove the water filter.
- Use the opening/closing tool (accessory).

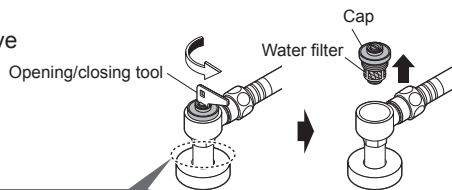

Hold the pipe with hands while loosening the cap.

- 5** Remove the water filter from the cap and clean it with a toothbrush or similar instrument.
- Do not use detergent.
  - Do not apply excessive force to the water filter.
  - (May cause deformation.)

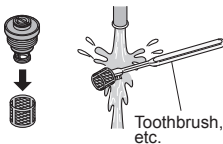

## Water Filter (Bowl Unit) (Approximately once every 6 months) (Continued)

- 6** Attach the water filter to the cap.



- 7** Install the cap of the water filter to the original position and tighten it with the opening/closing tool.

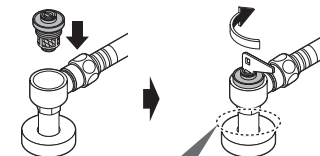

Hold the pipe with hands while tightening the cap.

- 8** Open the shutoff valve, and then install the shutoff valve cover.
- Check that there are no leaks in the shutoff valve or plumbing connections.

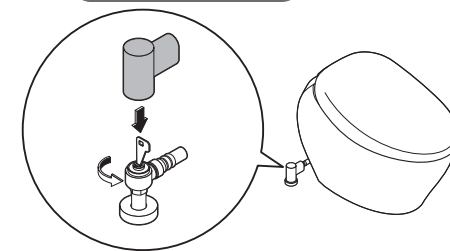

- 9** Switch the breaker on the distribution board to ON.
- The "Power" LED lights up.

# What to Do? If the water does not flow due to a power outage

## If the water does not flow due to a power outage (when water failure hasn't occurred)

■ You can flush the toilet with the hand lever (for flushing in case of power outage).

\*Pulling the hand lever does not flush the toilet when the power is supplied.

When testing the operation, switch the breaker on the distribution board to OFF.

- 1 Remove the rear cover of the main unit while pushing outward on the portion indicated by the ● in the figure.

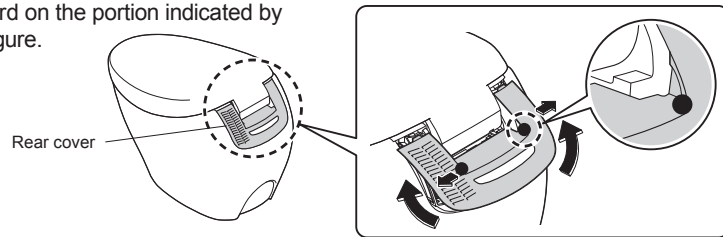

- 2 Pull the hand lever to where it stops. (about 30 seconds).

- The water surface in the bowl rises.

No water in the bowl overflows.

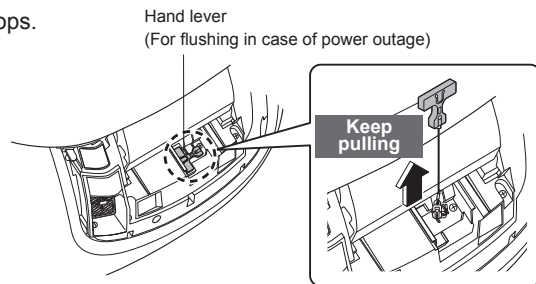

## If water does not flow during a power outage (when water failure hasn't occurred) (Continued)

- 3 When the beep sound is made and water supply stops, release the hand lever and return it to its original position.

- The toilet flushes.

\*You cannot flush the toilet for about 60 seconds after flushing it or releasing the hand lever halfway.

Wait at least about 60 seconds and then flush the toilet again.

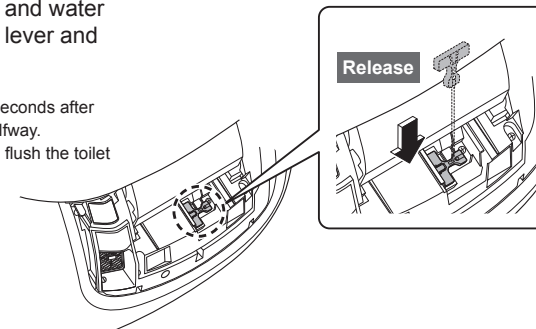

- 4 Install the rear cover of the main unit.

- Insert the cover tabs securely. (May cause damage to the rear cover.)

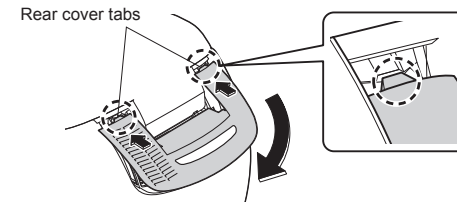

### Attention!

- When power is restored, be sure to perform a full flush. (To prevent waste from remaining in the discharge pipe.)

\* You can flush the toilet with a bucket. (Page 56)

# What to Do? If the water does not flow due to a power outage

If water does not flow during a long-term (2 days or more) power outage (when water failure hasn't occurred)

- When a power outage continues for a long period of time (2 days or more), you can insert batteries into the battery box and flush the toilet with the hand lever (for flushing in case of power outage).

### Attention!

- Be careful not to expose the battery box to water. (May cause malfunctions.)

- 1 Remove the accessory battery box from the bag.

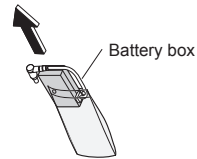

- 2 Insert two AA batteries properly in the battery box.

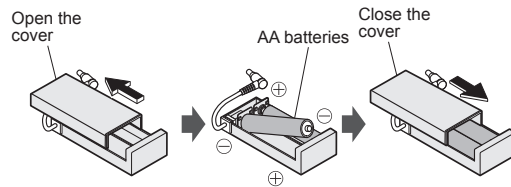

- 3 Put the battery in the bag.

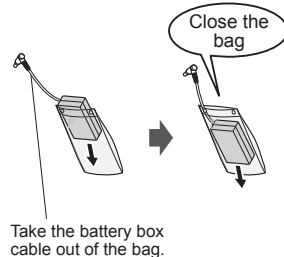

If water does not flow during a long-term (2 days or longer) power outage (when water failure hasn't occurred) (Continued)

- 4 Remove the rear cover of the main unit while pushing outward on the portion indicated by the ● in the figure.

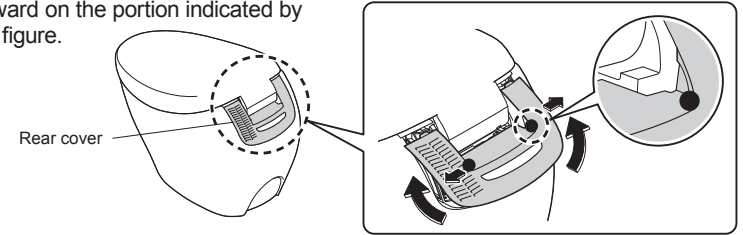

- 5 Connect the battery box cable to the battery box plug socket.

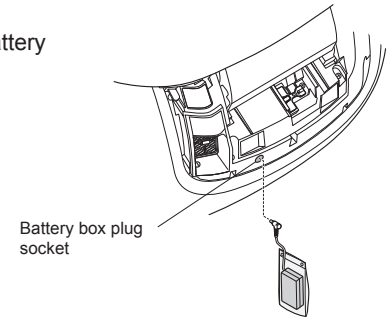

- To flush the toilet with the hand lever (Steps 2 3 on Page 52, 53)

- When the power outage recovers:
  - Unplug the battery box, take out the batteries, put the battery box cable inside the bag, and store in a safe place.
  - Install the rear cover of the main unit. (Step 4 on Page 53)

### ■ About the batteries

- Use dry cell, alkaline batteries.
- Be sure to follow "Safety Precautions" to prevent the batteries from rupturing, leaking fluid, etc. (Page 6, 8)

# What to Do? If the water does not flow due to a water service interruption

## If the water does not flow due to a water service interruption

- 1 Use a bucket to flush water.

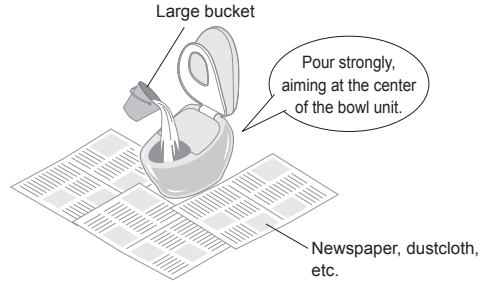

- 2 If the water level is low after flushing, add more water.
  - Prevents odors.

### Attention!

- If there is a water supply failure, set "Auto flushing" to "OFF". (Page 30)
- When water supply is restored, be sure to perform a full flush. (To prevent waste from remaining in the discharge pipe.)

# If you cannot operate with the remote control

## If you cannot operate with the remote control

- The toilet can be flushed by the Flush button on the top right corner of the toilet seat.

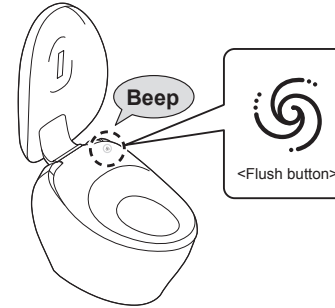

- If the low battery warning LED is flashing, replace the batteries.

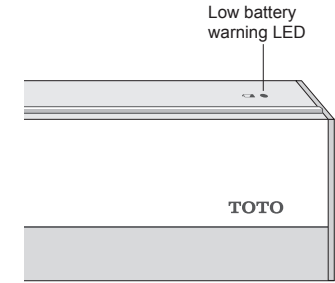

### ■ Replacing the batteries

- 1 Switch the breaker on the distribution board to OFF.
- 2 Remove the remote control from the hanger. (Page 14)
- 3 Open the battery cover and replace two AA batteries. (Page 14)
  - The low battery warning LED goes off.
- 4 Mount the remote control in the hanger.
- 5 Switch the breaker on the distribution board to ON.
  - The "Power" LED lights up.

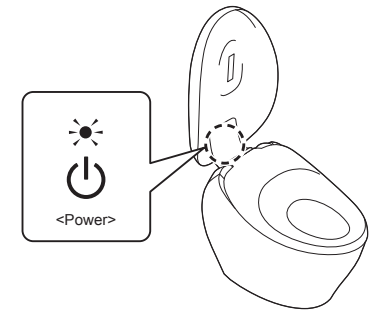

### Attention!

- "ON" and "OFF" settings of the functions such as the energy saver function may be canceled when the batteries are replaced. Set them again.

# What to Do? Freeze Damage Prevention

When the ambient temperature is likely to drop to 0°C or lower, take measures to prevent freezing.

### Attention!

- When the ambient temperature is likely to drop to 0°C or lower, do not use the energy saver feature. (May damage the product.)
- Warm the bathroom or take measures against freezing so that the ambient temperature does not drop below 0°C.
- Before starting to work, set "Auto flushing" (Page 30) and "Auto open/close (lid)" (Page 32) to "OFF".

## How to Freeze Damage Prevention (Dynamic Mode)

This method runs the water for the bowl unit and top unit automatically at a fixed interval in order to prevent freezing.

### How to Set (Page 40)

- Switch "Anti freezing" to "ON" with the remote control.

While Anti freezing is set to ON, it works as follows.

- The "Power" LED flickers.
- The toilet flushes at intervals of about 10 minutes.
- About 50 ml of water comes out from near the wand at intervals of about 5 minutes. (The wand remains retracted.)

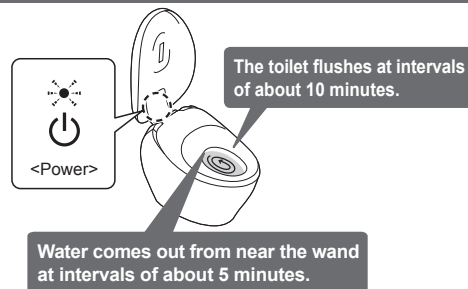

## Long Periods of Disuse

**If the toilet is in a location you will not visit for a long time, drain the water.**



(The water in the tank may cause malfunctions or become contaminated and cause skin irritation or other problems.)

(May cause freezing and damage to product.)

## How to drain the water

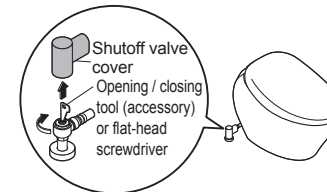
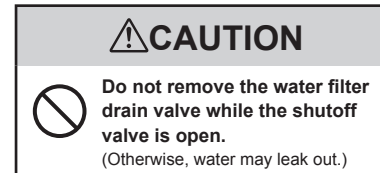
- 1 Remove the shutoff valve cover, and then close the shutoff valve.
  - The water supply stops.



- 2 Install the shutoff valve cover.
- 3  Press "Full flush" button on the remote control to drain the tank.
- 4  Press "Wand CLEAN" button.
  - Open the wand cover. (Release the pressure from the water supply pipe.)
- 5 Switch the breaker on the distribution board to OFF.

To the next page 

# What to Do? Long Periods of Disuse

## How to drain the water (Continued)

- 6** Drain the pipe.
- ① Remove the cover on the left side of the main unit and water filter drain valve.
- Insert the flat-head screwdriver firmly in the hook. (May cause damage.)
  - Loosen the water filter drain valve with a flat-head screwdriver and then pull it.

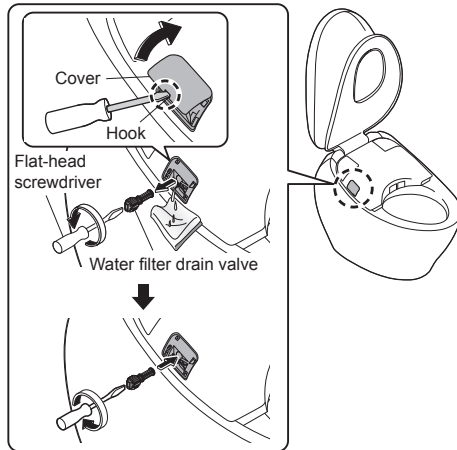

- ② After draining the water, install the water filter drain valve.
- Insert the water filter drain valve and use a flat-head screwdriver to tighten it securely.

- 7** Pull out the water drain lever.
- Water comes out from around the wand (about 20 seconds).



- 8** Release your hand to return the water drain lever to its original position.



- 9** Install the cover.

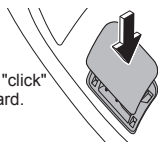

Push until a "click" sound is heard.

### ■ If water may get frozen

- Add antifreeze solution in the water in the bowl to prevent freezing. (The antifreeze solution should not be flushed out. Collect it before using the toilet and dispose of it.)

### ■ To use the this product again

- The water needs to be resupplied. (Page 61)

## Resupplying the Water

- 1** Remove the shutoff valve cover, and then open the shutoff valve.
- Check that water is not leaking from a pipe or the top unit.

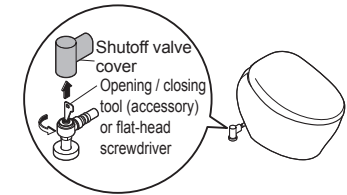

- 2** Install the shutoff valve cover.

- 3** Switch the breaker on the distribution board to ON.
- The "Power" LED lights up.

- 4** ① Discharge water from the wand.
- (1) Press and hold pressure on the seat sensor with your hand or arm (see page 9 for details).
  - (2) Press "Rear cleansing" button to discharge water from the wand.
    - Catch the water in a paper cup or other receptacle.
  - (3) Press "Stopping" button.

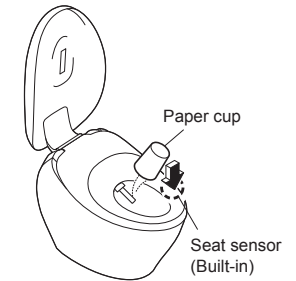

- ② Press "Full flush" button on the remote control.
- The toilet flushes while the tank fills with water. The LED on the main display flashes. It stays lit after the tank becomes full (about 80 seconds max.).
  - \* You cannot flush the toilet until water supply is complete. Never operate the toilet while the tank is filling with water.

### ■ If the remaining water has frozen and no water comes out

- Heat the inside of the bathroom, and warm the water supply hose and shutoff valve using a cloth soaked in warm water.

- 5** After the bowl unit fills with water, press ("Full flush" button) again.

# What to Do? Removal of Display Panel

To remove the display panel, follow the procedure below.

## How to remove the display panel

- 1 Switch the breaker on the distribution board to OFF.
- 2 Remove the remote control from the hanger.  
(Page 14)
- 3 Remove the hanger and display panel.

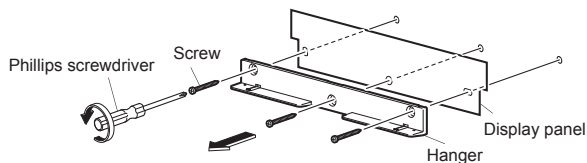

- 4 Screw the hanger on the wall.

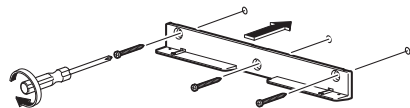

- 5 Mount the remote control in the hanger.

- 6 Switch the breaker on the distribution board to ON.  
• The "Power" LED lights up.

■ To install back the display panel, follow the procedure above.  
(Install the display panel at step 4.)

# Troubleshooting

First, try the actions described on pages 63 to 72.

If the problem persists, consult the installer, seller, or TOTO customer service (see contact information on the back cover).

**In the following case, switch the breaker on the distribution board to off and consult with TOTO customer service (see contact information on the back cover).**

- "Power" LED, "Seat" LED, and "Energy saver" LED are flickering
- "Seat" LED is flickering

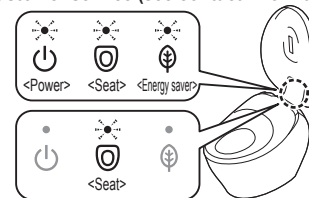

- The beep sound keeps sounding

**CAUTION**

! If a water leak occurs, close the shutoff valve.

## Please check first

### Is the Power LED lit?

- Is the "Power ON/OFF" setting "OFF"?  
→Switch it to "ON" with the remote control. (Page 15 Step 2-2)

- Is the "Power" LED on the main display flashing?  
→The "Anti freezing" is set to "ON". (Page 40, 58)

- Is the breaker on the distribution board turned on?  
→Check whether there is a power outage or the breaker has been turned "OFF".

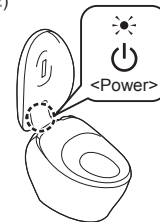

### Is the Energy saver LED lit?

- The energy saver (Page 24) is in operation while the LED is lit, so the toilet seat heater may be turned off.

### Is the remote control working?

- Is the low battery warning LED on the top surface of the remote control flashing?  
→Replace the batteries. (Pages 14, 57)

- Is there a metal object placed near the main unit or remote control?  
→Move the metal object.

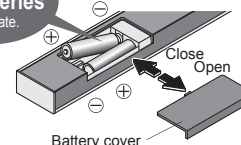

The remote control uses batteries to operate.





# Troubleshooting

## Rear Cleansing, Front Cleansing and Wand

Trouble	Please check	Ref. Page
<b>The wand (or cleansing water) does not come out</b>	●When the temperature is low, it takes time for the wand to come out after the remote control button is pressed because the water must be warmed up first.	—
	●Did you sit on the toilet continuously for 2 hours or longer? (If so, operation is stopped for safety purposes.) → Stand up from the seat and then use again.	—
	●If the water supply pressure drops significantly, for example if water is used elsewhere or if there is a water failure, the function may stop for safety. → Switch the breaker on the distribution board to OFF and wait about 10 seconds before inserting it again. If the same symptom reappears → There may be a malfunction. Consult with TOTO customer service (see contact information on the back cover).	—
	●When sitting on the toilet seat, is there a toilet seat cover or clothing on the seat sensor? Are you sitting without touching any part of the seat sensor? → Check the position of the seat sensor, then sit so your skin is in direct contact with the seat sensor.	9
	●Are you using a toilet seat cover, a toilet lid cover, or a seat for infants? → Remove any covers. When using a seat for infants or a soft highchair, remove after each use.	10
	●  Are you pressing "Wand CLEAN" button? •  When you press "Wand CLEAN" button, "ewater+" comes out from the vicinity of the wand to clean the wand. → To clean the wand with it extended, perform "Wand cleaning".	46
<b>The wand extends but the cleansing water does not come out/ The cleansing water pressure is weak</b>	●Has a water failure occurred? → ■ Press "Stopping" button on the remote control and wait until water service is restored.	—
	●Is the shutoff valve closed? → Fully open the shutoff valve.	15
<b>The cleansing water is cold</b>	●Is the water filter drain valve clogged with foreign matter? → Clean the filter.	48 - 49
	●Is the water pressure set to a low level?	18
<b>Stops in the middle of use</b>	●Is the warm water temperature set to "OFF" or a low level? ●When the temperature of the water supply or the bathroom is low, the water temperature may be low when first sprayed.	22 - 23
	●"Rear cleansing", "Rear soft cleansing", "Front cleansing", and "Wide front cleansing" stop automatically after about 5 minutes of continuous use. ●Does the seat sensor have difficulty detecting? → If you get up slightly from or sit towards the right of the seat, the seat sensor may temporarily stop detecting your presence.	9

## Rear Cleansing, Front Cleansing and Wand

Trouble	Please check	Ref. Page
<b>Water comes out unexpectedly from the wand</b>	●Is the "Power" LED (green) on the main display flashing? • The "Anti freezing (dynamic mode)" is set to "ON". (Water comes out from near the wand at about 5 minutes intervals and the bowl unit flushes at about 10 minutes intervals.)	40, 58
	●When you sit on the toilet seat, water comes out for several seconds while water is warmed up. ●Has the CLEAN indicator lit up in a cycle? • "Auto wand CLEAN" starts and the wand is cleaned.	— 17



## Warm air drying

Trouble	Please check	Ref. Page
<b>The dryer temperature is low</b>	●Is the dryer temperature set to low level?	22 - 23
<b>Stops in the middle of use</b>	●The feature stops automatically after about 10 minutes of continuous use.	—
	●Does the seat sensor have difficulty detecting? → If you get up slightly from or sit towards the right of the seat, the seat sensor may temporarily stop detecting your presence.	9

## Flushing

Trouble	Please check	Ref. Page
<b>For not flushing</b>	●Is the shutoff valve fully open?	15
	●Has a power outage occurred? → You can flush the toilet with the hand lever (for flushing in case of power outage).	52 - 53
	●Has a water failure occurred? → Use a bucket to flush water.	56
<b>The toilet does not flush even when the button of remote control is pressed</b>	●Is the LEDs on the main display flashing? • The tank is filling with water. (This takes about 60 seconds maximum.)	—
<b>The bowl unit does not clean automatically or the timing is delayed (Auto flushing)</b>	●Is "Auto flushing" set to "OFF"? → Set to "ON".	30
	●Even if "Auto flushing" is set to "ON", it is not available in the following instances. • About 60 seconds after the toilet is flushed. → Wait about 60 seconds and flush the toilet with the remote control. • When the time spent sitting on the toilet seat or standing in front of the bowl unit is less than about 6 seconds. → Flush with the remote control. • When staying in front of the bowl unit after standing and using the toilet. → The water flows after a maximum of about 10 seconds from when you leave the bathroom.	— — —

# Troubleshooting

Flushing		
Trouble	Please check	Ref. Page
The bowl unit does not clean automatically or the timing is delayed (Auto flushing)	<ul style="list-style-type: none"> <li>● When sitting on the toilet seat, is there a toilet seat cover or clothing on the seat sensor? Are you sitting without touching any part of the seat sensor? → Check the position of the seat sensor, then sit so your skin is in direct contact with the seat sensor.</li> </ul>	9
	<ul style="list-style-type: none"> <li>● The timing for the "Auto flushing" can be changed. (After about 10 seconds → after about 5 or 15 seconds)</li> </ul>	30
The toilet does not flush even when the Flush button on the top right corner of the toilet seat is pressed.	<ul style="list-style-type: none"> <li>● Push the Flush button with your finger directly on the button.</li> </ul>	9
The toilet flushes on its own	<ul style="list-style-type: none"> <li>● Is "Auto flushing" set to "ON"? → You can also turn it "OFF".</li> </ul>	30
	<ul style="list-style-type: none"> <li>● Does the seat sensor have difficulty detecting? → If you get up slightly from or sit towards the right of the seat, the seat sensor may not detect, and thus auto flushing may occur during use.</li> </ul>	9
	<ul style="list-style-type: none"> <li>● Is the "Power" LED (green) on the main display flashing? • The "Anti freezing (dynamic mode)" is set to "ON". (Water comes out from near the wand at about 5 minutes intervals and the bowl unit flushes at about 10 minutes intervals.)</li> </ul>	40, 58
Waste material does not flush down completely	<ul style="list-style-type: none"> <li>● Is the shutoff valve fully open?</li> </ul>	15
	<ul style="list-style-type: none"> <li>● Is the water filter clogged? → Clean the filter.</li> </ul>	50 - 51
	<ul style="list-style-type: none"> <li>● Is the water supply to the toilet disrupted by other running water fixtures? → Cease using other fixtures and then flush the toilet.</li> </ul>	—
	<ul style="list-style-type: none"> <li>● Are the flush and light flush buttons being used correctly? •  (For solid waste): up to 10 m of toilet paper (single) •  (For liquid waste): up to 3 m of toilet paper (single)</li> </ul>	19
	<ul style="list-style-type: none"> <li>● Flushing may be difficult depending the consistency of the waste material. → Flush the toilet again. If the bowl unit is not cleansed with a flushing, remove the stains with a brush or similar instrument.</li> </ul>	44 - 45
	<ul style="list-style-type: none"> <li>● When the tank is filling, you cannot flush the toilet. → Once the "Power" LED on the main display is lit and the tank fills up with water, flush the toilet.</li> </ul>	—
	<ul style="list-style-type: none"> <li>● It may be difficult to flush down substances with a higher specific gravity than water, such as barium. → Flush the toilet again. If the bowl unit is not cleansed by flushing, remove the stains with a brush or similar instrument.</li> </ul>	44 - 45
There is residue on the bowl unit surface	<ul style="list-style-type: none"> <li>● Oil and other hard-to-see grime may stick to the bowl unit surface. → Clean with (non-abrasive) neutral toilet detergent.</li> </ul>	44 - 45

Flushing		
Trouble	Please check	Ref. Page
A small amount of water flows in the bowl unit after the unit flushes	<ul style="list-style-type: none"> <li>● If the water supply pressure drops significantly, for example if water is used elsewhere or if there is a water failure, water is supplied so that the water surface in the bowl unit rises to a certain level. <ul style="list-style-type: none"> <li>• If the same symptom reappears → There may be a malfunction. Consult with TOTO customer service (see contact information on the back cover).</li> </ul> </li> </ul>	—
Pulling the hand lever (for flushing in case of power outage) does not flush the toilet	<ul style="list-style-type: none"> <li>● Pulling the hand lever does not flush the toilet when the power is supplied. When testing the operation, switch the breaker on the distribution board to OFF.</li> <li>● To flush the toilet with the hand lever, keep pulling the lever until the beep sound is made and water supply stops.</li> <li>● You cannot flush the toilet for about 60 seconds after flushing it with the hand lever or releasing the hand lever halfway. → Wait at least 60 seconds and then flush the toilet again.</li> <li>● If power outage lasts for a long period (2 days or more), insert batteries in the accessory battery box.</li> <li>● If the toilet does not flush with batteries in the battery box, the batteries are running out. → Replace them with new ones.</li> </ul>	52 - 53 —

Toilet Seat and Toilet Lid (Auto open/close (lid))		
Trouble	Please check	Ref. Page
The toilet lid does not open automatically	<ul style="list-style-type: none"> <li>● Is "Auto open/close (lid)" set to "OFF"? → Set to "ON".</li> <li>● Even when set to "ON", "Auto open/close (lid)" is not performed for about 15 seconds after the toilet seat or toilet lid is closed. <ul style="list-style-type: none"> <li>• When the toilet lid is closed by hand (To make the product more user-friendly, a time interval is set from when the lid is closed to when it will open next.) → Move away from the toilet and wait at least about 15 seconds before approaching the bowl unit again or open and close by hand.</li> </ul> </li> </ul>	32 —
	<ul style="list-style-type: none"> <li>● Is "Auto open delay" set to "30 seconds" or "90 seconds"?</li> </ul>	33
	<ul style="list-style-type: none"> <li>● After switching the breaker on the distribution board to ON, the toilet lid does not open automatically for about 10 seconds. → Open and close by hand.</li> </ul>	—
	<ul style="list-style-type: none"> <li>● Is a toilet lid or seat cover installed? → Remove any covers.</li> </ul>	10
	<ul style="list-style-type: none"> <li>● Detection by the body sensor may be difficult when the toilet is used by someone small, such as a child.</li> </ul>	—
	The toilet lid does not close automatically	<ul style="list-style-type: none"> <li>● Is "Auto open/close (lid)" set to "OFF"? → Set to "ON".</li> <li>● The toilet lid will close roughly 90 seconds after you leave the bathroom, assuming you sat on the toilet seat for at least 6 seconds.</li> <li>● The lid will then close after about 5 minutes after you leave the bathroom. <ul style="list-style-type: none"> <li>• When you did not sit on the toilet seat</li> <li>• When you sat on the toilet seat for than about 6 seconds.</li> <li>• When you stood in front of the bowl unit for less than about 6 seconds.</li> </ul> </li> </ul>

# Troubleshooting

## Toilet Seat and Toilet Lid (Auto open/close (lid))

Trouble	Please check	Ref. Page
The toilet lid opens on its own	<ul style="list-style-type: none"> <li>● Because the body sensor can detect movement through the wall or door in front of the toilet, the "Auto open/close (lid)" function may cause the toilet lid to open automatically even when you are outside of the bathroom.                             <ul style="list-style-type: none"> <li>→ You can also set "Auto open/close (lid)" to "OFF".</li> </ul> </li> <li>● Is a urinal or wash basin also installed in the bathroom?                             <ul style="list-style-type: none"> <li>→ The body sensor may detect someone using the urinal, causing the toilet lid to open or close.</li> </ul> </li> </ul>	32 —
	<ul style="list-style-type: none"> <li>● Is "Auto open/close (lid)" set to "ON"? → You can turn it "OFF".</li> <li>● Is "Auto open delay" set to "25 seconds"?</li> <li>● When sitting on the toilet seat, is there a toilet seat cover or clothing on the seat sensor? Are you sitting without touching any part of the seat sensor?                             <ul style="list-style-type: none"> <li>→ Check the position of the seat sensor, then sit so your skin is in direct contact with the seat sensor.</li> </ul> </li> </ul>	32 32 9
The toilet lid and toilet seat open at the same time	<ul style="list-style-type: none"> <li>● Is "Seat/lid" set to "Seat-lid"?</li> </ul>	33
Stops (or closes) while opening	<ul style="list-style-type: none"> <li>● If the lid or seat hits an obstruction the first time it opens after switching ON the breaker on the distribution board, it may stop (or close) partway during the next operation.                             <ul style="list-style-type: none"> <li>→ Eliminate any obstructions and switch the breaker on the distribution board to OFF. Switch it to ON again after about 5 seconds. Then press  "Opening and closing the toilet seat" button.</li> </ul> </li> </ul>	19
Cannot open or close with the remote control	<ul style="list-style-type: none"> <li>● If it opens automatically → Check "Is the remote control working?"</li> </ul>	63

## Toilet Seat and Toilet Lid

Trouble	Please check	Ref. Page
The toilet seat is cold	<ul style="list-style-type: none"> <li>● Is the "Seat" LED flickering?                             <ul style="list-style-type: none"> <li>→ Consult with TOTO customer service (see contact information on the back cover).</li> </ul> </li> </ul>	—
	<ul style="list-style-type: none"> <li>● Is the toilet seat temperature set to "OFF" or a low level?</li> <li>● If the time spent sitting on the toilet seat is short, the seat may not warm up.</li> </ul>	22 - 23 —
	<ul style="list-style-type: none"> <li>● Is energy saver in operation?                             <ul style="list-style-type: none"> <li>• The energy saver feature is on when the "Energy saver" LED is on and the "Power" LED is off on the main display.</li> </ul>                             When you approach the seat or sit on the seat, the toilet seat heater is turned on temporarily and the seat is warmed to the setting temperature in about 60 seconds.                             <ul style="list-style-type: none"> <li>→ You can turn it "OFF" if the energy saver feature is "ON".</li> </ul> </li> </ul>	24 - 25 26 - 27
	<ul style="list-style-type: none"> <li>● Have you been seated for a long time?                             <ul style="list-style-type: none"> <li>• After about 20 minutes of sitting, the temperature starts going down, and after about 1 hour, the toilet seat heater is turned "OFF". → Stand up from the seat and then use again</li> </ul> </li> </ul>	—
	<ul style="list-style-type: none"> <li>● Is a toilet lid or seat cover installed? → Remove any covers.</li> </ul>	10

## Toilet Seat and Toilet Lid

Trouble	Please check	Ref. Page
The toilet seat is hot	<ul style="list-style-type: none"> <li>● If you hear a beep sound, switch the breaker on the distribution board to off and consult with TOTO customer service (see contact information on the back cover).</li> </ul>	—

## Energy Saver

Trouble	Please check	Ref. Page
The energy saver LED does not light up	<ul style="list-style-type: none"> <li>● Did you switch the breaker on the distribution board to off or was there a power outage?                             <ul style="list-style-type: none"> <li>• The "Energy saver" LED on the main display may go off when the power is turned on even if the energy saver feature is "ON".</li> <li>(It will turn on within about 24 hours since the setting is retained.)</li> </ul> </li> </ul>	—
The timer energy saver feature is not working	<ul style="list-style-type: none"> <li>● Did you replace the remote control batteries?                             <ul style="list-style-type: none"> <li>• "Timer energy saver" may be canceled when the batteries are replaced.</li> <li>→ Set the timer energy saver again at the time you want to start it.</li> </ul> </li> </ul>	26
The auto energy saver+ feature is not working	<ul style="list-style-type: none"> <li>● Because the function takes several days learning the usage conditions before starting energy saver, the amount of energy saving may be low, depending on the frequency of use.</li> </ul>	—
	<ul style="list-style-type: none"> <li>● Did you replace the remote control batteries?                             <ul style="list-style-type: none"> <li>• The setting may be canceled when the batteries are replaced. → Set them again.</li> </ul> </li> </ul>	26

## Deodorizer

Trouble	Please check	Ref. Page
The deodorizer seems to be not working	<ul style="list-style-type: none"> <li>● Is "Deodorizer" set to "OFF"? → Set to "ON".</li> </ul>	35
	<ul style="list-style-type: none"> <li>● Even after sitting down, you do not hear operation sounds.                             <ul style="list-style-type: none"> <li>→ Sit so your skin is in direct contact with the seat sensor.</li> <li>If you hear an operation sound when you sit on the toilet seat.                                     <ul style="list-style-type: none"> <li>→ Clean the deodorizing filter.</li> </ul> </li> </ul> </li> </ul>	9 47
A strange odor is emitted	<ul style="list-style-type: none"> <li>● Are you using an air freshener or deodorizer that you purchased separately?                             <ul style="list-style-type: none"> <li>• Doing so may reduce the effectiveness of the NEOREST deodorizer or cause strange odors.</li> <li>→ Remove the air freshener or deodorizer.</li> </ul> </li> </ul>	—
The auto power deodorizer does not work	<ul style="list-style-type: none"> <li>● Is "Auto power deodorizer" set to "OFF"? → Set to "ON".</li> <li>● It starts about 10 seconds after you stand up from the toilet seat.</li> </ul>	35 —

# Troubleshooting

Sanitary		
Trouble	Please check	Ref. Page
<b>The soft light, bowl light, and CLEAN indicator do not light up</b>	<ul style="list-style-type: none"> <li>● Is the setting "OFF"? → Set to "ON".</li> <li>● If the CLEAN indicator LED is not lit, it is time to replace the component that generates "ewater+". Consult the installer, seller, or TOTO customer service (see contact information on the back cover).</li> </ul>	36 - 37 —
<b>Pre-mist and after-mist do not work</b>	<ul style="list-style-type: none"> <li>● Is "Auto bowl CLEAN" set to "OFF"? → Set to "ON".</li> <li>● The after-mist will work roughly 90 seconds after you leave the bathroom, assuming you sat on the toilet seat for at least 6 seconds.</li> <li>● The following functions do not work when the toilet seat is open.               <ul style="list-style-type: none"> <li>• Is "Seat/lid" of "Auto open/close (lid)" set to "Seat-lid"? → You can change it to "Lid".</li> </ul> </li> <li>● The pre-mist/after-mist may not work if the toilet is used immediately after the previous person leaves the bathroom.</li> </ul>	34 17 —
	<ul style="list-style-type: none"> <li>● Because the body sensor can detect movement through the wall or door in front of the toilet, the "Auto bowl CLEAN" function may cause the toilet to pre-mist even when you are outside of the bathroom. → You can also set "Auto bowl CLEAN" to "OFF".</li> <li>● If the cleansing functions (e.g., Rear cleansing and Front cleansing) are not used for about 8 hours, "Auto bowl CLEAN" starts and mist is sprayed inside the bowl unit.</li> </ul>	34 —
	<ul style="list-style-type: none"> <li>● When "Full flush", "Rear cleansing", or "Rear soft cleansing" have not been used in about 10 hours the UV lamp lights up.</li> </ul>	—
<b>The UV lamp illuminates the inside of the toilet bowl.</b> <sup>*1</sup>	<ul style="list-style-type: none"> <li>● The toilet bowl surface needs to be cleaned. → Clean with a toilet brush or the like using commercially available hydrochloric acid-based or inorganic acid-based detergent.               <ul style="list-style-type: none"> <li>• For daily cleaning, use neutral detergent.</li> </ul> </li> <li>● Is "Auto open/close (lid)" set to "OFF"? → If it is set to "OFF", the UV lamp function will not work when the toilet lid is open.</li> </ul>	— 32
<b>The toilet bowl surface repels water or tends to get dirty easily</b> <sup>*1</sup>	<ul style="list-style-type: none"> <li>● The UV lamp does not light up in the following cases:               <ul style="list-style-type: none"> <li>• When the toilet lid is open (when "Auto open/close (lid)" is "OFF," etc.)</li> <li>• When "Full flush", "Rear cleansing", or "Rear soft cleansing" were not used for solid waste or liquid waste.</li> </ul> </li> </ul>	—

\*1 Other than the CS900\*\*\*

Others			
Trouble	Please check	Ref. Page	
<b>The top unit makes a sound</b>	When entering the bathroom	<ul style="list-style-type: none"> <li>● If "Auto bowl CLEAN" is "ON", you may hear that pre-mist is spraying mist in the bowl unit to make it more difficult for dirt to adhere. → You can turn it "OFF".</li> </ul>	34
	When using the cleansing functions (Rear cleansing, Soft rear cleansing, or Front cleansing)	<ul style="list-style-type: none"> <li>● You can hear the sound of the pump operating while cleansing water is being supplied.</li> </ul>	—
	When moving away from the bowl unit after use	<ul style="list-style-type: none"> <li>● When "Auto power deodorizer" is "ON", operation sounds are made while the deodorizing power increases for 60 seconds after you stand up from the toilet seat. → You can turn it "OFF".</li> <li>● If "Auto wand CLEAN" is "ON" and you use the cleansing functions (e.g., Rear cleansing and Front cleansing), you may hear that the wand is extended and cleaned with "ewater+". → You can turn it "OFF".</li> </ul>	35 34
	When leaving the bathroom after use	<ul style="list-style-type: none"> <li>● If "Auto bowl CLEAN" is "ON" and you sit on the toilet seat and use the toilet, you may hear that mist of "ewater+" is sprayed inside the bowl unit. → You can turn it "OFF".</li> <li>● You may hear that the wand is extended and the remaining water in the product is drained when "Auto wand CLEAN" and other functions are performed.</li> </ul>	34 —
	When not using the product (e.g., at night)	<ul style="list-style-type: none"> <li>● You may hear the following sounds if "Auto wand CLEAN" or "Auto bowl CLEAN" is "ON" and if you do not use the cleansing functions (e.g., Rear cleansing and Front cleansing) for about 8 hours.               <ul style="list-style-type: none"> <li>"Auto wand CLEAN": Sound of cleaning the wand with "ewater+"</li> <li>: Sound of extending the wand and draining remaining water from the product after operation of functions</li> <li>"Auto bowl CLEAN": Sound of spraying mist of "ewater+" mist inside the bowl unit</li> </ul>               → You can turn it "OFF".</li> <li>● Because the body sensor can detect movement through the wall or door in front of the toilet, the "Auto open/close (lid)" and "Auto bowl CLEAN" functions may cause the toilet to pre-mist, or the lid to open, even when you are outside of the bathroom. → You can also set "Auto open/close (lid)" or "Auto bowl CLEAN" to "OFF".</li> </ul>	34 32, 34

# Troubleshooting

Others		
Trouble	Please check	Ref. Page
Water is leaking from the plumbing connections	<ul style="list-style-type: none"> <li>● If any nuts in a connection are loose, firmly tighten them with a tool such as a monkey wrench.                             <ul style="list-style-type: none"> <li>→ If the water leak does not stop, close the shutoff valve and consult with TOTO customer service (see contact information on the back cover).</li> </ul> </li> </ul>	—
The display on the remote control goes out	<ul style="list-style-type: none"> <li>● The display goes out when no button on the remote control is pressed for about 60 seconds or more.</li> </ul>	—
You are not sure if the Air deodorizer has been set or not	<ul style="list-style-type: none"> <li>● Since this product does not include the "Air deodorizer" function, it cannot be set even if you operate the remote control.</li> </ul>	—
Water splashes up when using the toilet	<ul style="list-style-type: none"> <li>● The water in the bowl unit that is used to mask the smell of excrement is the cause of the splashing.                             <ul style="list-style-type: none"> <li>→ Adding a layer of toilet paper on the surface of the water can slightly dampen splashing.</li> </ul> </li> </ul>	—
When flushing, you hear a squishing sound underneath the floor	<ul style="list-style-type: none"> <li>● There are cases when the sound is made inside the discharge pipe because of the device to ensure water in the bowl unit after the unit flushes.</li> </ul>	—
When flushing, You hear a gurgling sound	<ul style="list-style-type: none"> <li>● When the toilet is flushed together with waste material, the sound is a result of air, waste material and water being pulled through the system.</li> </ul>	—
There are black stain on or around the bowl unit	<ul style="list-style-type: none"> <li>● Ammonia in urine may cause black stains.                             <ul style="list-style-type: none"> <li>→ If urine has splashed on the bowl unit or floor, wipe it immediately.</li> </ul> </li> </ul>	—
There is black or pink slime on the toilet bowl surface	<ul style="list-style-type: none"> <li>● It is a result of growth of airborne fungal spores or bacteria that feed on filth on the toilet bowl.                             <ul style="list-style-type: none"> <li>→ Clean with (non-abrasive) neutral toilet cleaner.</li> </ul> </li> </ul>	—
There are water droplets on the bowl unit surface	<ul style="list-style-type: none"> <li>● Condensation occurs when the humidity is high, and there is a significant difference between water and room temperatures.                             <ul style="list-style-type: none"> <li>→ Wipe off droplets with dry cloth.</li> <li>(Condensation can build up on condensation-proof bowls when the difference between room and water temperatures exceeds 15°C and the ambient humidity levels reach 80%.)</li> </ul> </li> </ul>	—

# Specifications

Item				NX1, NX2	
Rated power supply				AC 220-240 V, 50/60 Hz	
Rated power consumption				835-845 W	
Maximum power consumption				1445-1458 W <when the temperature of the water supply is 0°C>	
Type of water heater				Instantaneous type	
Power cord length				1.2 m (For Singapore, 5.0 m)	
Water protection level				IPX4	
Bowl Unit	Flush volume			Full 3.8 L (For Australia, 4.5L), Light 3.0 L	
	Water supply system			Direct supply, Pressurized supply	
	Flush type			Cyclone flushing	
	Bowl style			Elongated	
Top Unit	Cleansing	Anti freezing	Dynamic mode	Flush volume (dynamic)	41 L/h <sup>1</sup>
			Flush volume (dynamic)		
		Heated seat	Spray volume	Rear cleansing	Approx. 0.32 to 0.43 L/min <at 0.2 MPa water pressure>
				Rear soft cleansing	Approx. 0.32 to 0.43 L/min <at 0.2 MPa water pressure>
	Deodorizer		Front cleansing	Approx. 0.29 to 0.43 L/min <at 0.2 MPa water pressure>	
			Wide front cleansing	Approx. 0.35 to 0.43 L/min <at 0.2 MPa water pressure>	
	Warm air dryer	Water temperature			Adjustable temperature range: OFF, about 30°C to 40°C
		Heater capacity			1200-1428 W
		Safety device			Temperature fuse
		Backflow prevention device			Vacuum breaker, Check valve
Deodorizer		Surface temperature			Adjustable temperature range: OFF, about 28°C to 36°C <With auto energy saver+ in operation: OFF>
		Heater capacity			560-670 W
	Safety device			Temperature fuse	
Warm air dryer	Method			O <sub>2</sub> deodorization	
	Airflow volume			Normal mode: approx. 0.09 m <sup>3</sup> /min, Power mode: approx. 0.16 m <sup>3</sup> /min	
	Power consumption			Normal mode: approx. 1.7 W, Power mode: approx. 5.3 W	
	Warm air temperature <sup>*2</sup>			Adjustable temperature range: about 37°C to 55°C	
Warm air dryer	Airflow volume			Approx. 0.29m <sup>3</sup> /min	
	Heater capacity			200-238 W	
	Safety device			Temperature fuse	
Water supply pressure				Minimum required water pressure: 0.05 MPa <Dynamic, 10 L/min>, Maximum water pressure: 0.75 MPa <Static>	
Water supply temperature				0-35°C	
Working ambient temperature				0-40°C	
Dimensions				W 468 mm x D 800 mm x H 565 mm	
Weight				About 61 kg	

\*1 The flush volume changes depending on water pressure. \*2 Temperature around the warm air outlet measured by TOTO.

● When disposing of this product, please follow your local or state guidelines for proper disposal.

## Safety Guidelines

### A warm-water cleaning toilet seat is an electric appliance.

Continued use after malfunction occurs or use when its life-time is expired may deteriorate the electric components, producing smoke or resulting in a fire.

### For safe use of the warm-water cleaning toilet seat

Periodical inspection is recommended.

- Please consider replacing the product when its life-time is expired.



If any abnormality of the product is observed, stop using it and consult the installer, seller or the contact listed on the back cover of this manual.

(A damaged product may cause a fire, electric shock, or may flood the floors with water.)

- Turn off the power immediately and close the shutoff valve.

## Limited Warranty

### LIMITED ONE YEAR WARRANTY

1. TOTO warrants its products to be free from manufacturing defects under normal use and service for a period of one (1) year from the date of purchase. This warranty is extended only to the ORIGINAL PURCHASER.
2. TOTO's obligations under this warranty are limited to repair or replacement, at TOTO's option, of products or parts found to be defective, provided that such products were properly installed and used in accordance with this OWNER'S MANUAL. TOTO reserves the right to make such inspections as may be necessary to determine the cause of the defect. TOTO will not charge for labor or parts in connection with warranty repairs or replacements. **TOTO is not responsible for the cost of removal, return and/or reinstallation of products.**
3. This warranty does not apply to the following items:
  - a) Damage or loss sustained in a natural calamity such as fire, earthquake, flood, thunder, electrical storm, etc.
  - b) Damage or loss resulting from any unreasonable use, misuse, abuse, negligence, or improper maintenance of the product.
  - c) Damage or loss resulting from removal, improper repair, or modification of the product.
  - d) Damage or loss resulting from sediments or foreign matter contained in a water system.
  - e) Damage or loss resulting from the quality of water in the region where the product is used.
  - f) Damage or loss resulting from improper installation or from installation of a unit in a harsh and/or hazardous environment.
  - g) Damage or loss resulting from electrical surges or lightning strikes or other acts which are not the fault of TOTO or which the product is not specified to tolerate.
  - h) Damage or loss resulting from normal and customary wear and tear, such as gloss reduction, scratching or fading over time due to use, cleaning practices or water or atmospheric conditions.
4. This warranty gives you specific legal rights. You may have other rights which vary from country to country.
5. To obtain warranty repair service under this warranty, you must take the product or deliver it prepaid to a TOTO service facility, together with a letter stating the problem, or contact a TOTO distributor or product service contractor, or directly to TOTO sales office. If, because of the size of the product or nature of the defect, the product can not be returned to TOTO, receipt by TOTO of written notice of the defect shall constitute delivery. In such case, TOTO may choose to repair the product at the purchaser's location or pay to transport the product to a service facility.

WARNING! TOTO shall not be responsible or liable for any failure of, or damage to, this Product caused by either chloramines in the treatment of public water supply or cleaners containing chlorine (calcium hypochlorite).

NOTE: The use of a high concentrate chlorine or chlorine related product's can seriously damage the fittings. This damage can cause leakage and serious property damage.

THIS WRITTEN WARRANTY IS THE ONLY WARRANTY MADE BY TOTO. REPAIR OR REPLACEMENT AS PROVIDED UNDER THIS WARRANTY SHALL BE THE EXCLUSIVE REMEDY AVAILABLE TO THE PURCHASER. TOTO SHALL NOT BE RESPONSIBLE FOR LOSS OF USE OF THE PRODUCT OR FOR OTHER INCIDENTAL, SPECIAL, OR CONSEQUENTIAL DAMAGE OR EXPENSES INCURRED BY PURCHASER, OR FOR LABOR OR OTHER COSTS DUE TO INSTALLATION OR REMOVAL, OR COSTS OF REPAIRS BY OTHERS, OR FOR ANY OTHER EXPENSE NOT SPECIFICALLY STATED ABOVE. EXCEPT TO THE EXTENT PROHIBITED BY APPLICABLE LAW, ANY IMPLIED WARRANTIES, INCLUDING THAT OF MERCHANTABILITY OR FITNESS FOR USE, ARE EXPRESSLY LIMITED TO THE DURATION OF THIS WARRANTY. SOME STATES DO NOT ALLOW LIMITATIONS ON HOW LONG AN IMPLIED WARRANTY LASTS, OR THE EXCLUSION OR LIMITATION OF INCIDENTAL OR CONSEQUENTIAL DAMAGE, SO THE ABOVE LIMITATION AND EXCLUSION MAY NOT APPLY TO YOU.

MEMO

MEMO

MEMO

MEMO