

TOTO

使用说明书
Instructions for operation

使用产品前请仔细阅读本使用说明书，并保留备用。
Before using product, read these instructions
for operation carefully and retain it for future reference.

TOTO

OG554Y
2022.04

目录

目 录

目 录	1
明细单	2
使用条件与使用上的注意	3
使用上的注意	4
使用上的注意与保养	5
产品示意图	6
使用方法	7~9
拆卸与检查	10~13
产品保修卡	14
合格证	15

明细单

明细单

水嘴主体部	1套
固定花洒部	1个
连接弯管(含螺母)	1套
连接直管(含固定支架、手持花洒支架)	1套
固定支架接手	1套
偏心接脚	2个
装饰盖	3个
螺钉等附件	1套
施工说明书	1本
使用说明书	1本

使用此明细单的产品包括:



- TBW01301* 铜合金双柄双控淋浴柱·带固定花洒
(3段切换·单功能固定花洒)
- TBW01302* 铜合金双柄双控淋浴柱·带固定花洒
(2段切换·单功能固定花洒)
- TBW01303* 铜合金双柄双控淋浴柱·带固定花洒
(2段切换·多功能固定花洒)

使用条件与使用上的注意

使用条件

1. 供冷水*热水压强:
最低压强……………0.05MPa (流动压)
最高压强……………1.0MPa (静压)
推荐使用压强:
TBW01301*………0.12-0.5MPa (流动压)
TBW01302*………0.12-0.5MPa (流动压)
TBW01303*………0.15-0.5MPa (流动压)
检测压强……………1.6MPa (静压)
2. 供水温度在4℃~90℃, 建议使用热水温度60±5℃, 供热水请勿使用蒸汽。
3. 使用环境温度0℃以上, 60℃以下, 如果不高于0℃, 水嘴会出现变形、冻裂等现象, 同时高于60℃可能会损坏花洒内部结构。
4. 为防止花洒内部损坏, 花洒侧吐水温度不得超过60℃, 建议使用温度45℃以下。
5. 长时间不使用时, 可能导致水嘴内部及外部锈蚀不能使用等现象。
6. 如果您需要废弃本产品, 请勿将其作为一般生活垃圾处理, 请依照法规经由独立的回收体系进行合适的处理、恢复和回收。
7. 本说明书中的产品具有清洗功能。
※ 为了达到最好的安装与使用效果, 水嘴本体推荐与「TOTO」手握式系列花洒一起配套使用。

使用上的注意

-  **警告** 表示如果无视此标志而误操作时, 有可能造成人员重伤或死亡。
-  **注意** 表示如果无视此标志而误操作时, 有可能造成人身伤害或财产损失。

警告

1. 幼儿禁止使用或幼儿需要由成年人监护使用、老人和残障人士等特殊群体应在有行动能力人员陪同下使用。
2. 水嘴的供热水一侧处于高温状态, 请勿使皮肤直接接触五金配件表面, 否则可能会烫伤。
3. 请勿配反冷*热水配管, 否则可能会烫伤。
4. 供热水请勿使用蒸汽, 否则可能会烫伤。

使用上的注意

警告

5. 当直接从吐水口侧切换到淋浴器侧或从淋浴器侧切换到吐水口侧时, 水温会发生变化, 要用手测试水温后再使用, 否则可能会烫伤。
6. 如果客户不使用我司水嘴自带的进水口过滤网, 可能会出现阀芯因异物进入而导致的漏水或破损的风险。

注意

1. 由于陶瓷阀芯是较精密的部件, 请勿擅自分解, 否则可能会造成漏水等不良。
2. 请勿撞击本产品, 否则可能会造成故障、漏水。
3. 必须使用中性洗涤剂清洗, 中性以外的洗涤剂会破坏镀层或使表面变色。
4. 不得使用酸性洗涤剂和去污粉、抛光粉等含粗颗粒的洗涤剂和尼龙刷, 否则可能会破坏镀层等。
5. 可使用软布擦拭, 间或用机油或车用蜡浸布擦拭, 但请勿接触树脂部件, 否则可能失去光泽和产生锈蚀。
6. 建议不要长时间不使用, 否则可能会导致水嘴内部以及外部锈蚀不能使用等现象。
7. 随着产品式样的不断更新, 实物存在与图示不符的情况, 但基本安装、使用原理相同。
8. 切替阀按压切替时(手持花洒↔吐水口)推荐理想的压力为0.4Mpa, 超过0.4Mpa时按压切替会比较困难, 建议关闭阀芯再次打开阀芯使用。
9. 由于出厂前进行通水检查, 故水嘴内可能有残留水, 并非产品有问题。
10. 本产品必须远离暖风机或浴霸等发热源, 否则可能会损坏花洒表面和内部结构。
11. 在可能结冰的场所使用时, 要切实做好防冻措施。因结冰, 零件破损, 有可能导致漏水, 造成财产损失。因结冰而造成的破损即使在保修期内也是有偿修理。请不要让产品的环境温度低于0℃。

使用上的注意与保养

防冻措施

在可能结冰的场所使用时，要切实做好防冻措施。

1. 产品结冰的话零件损坏，成为漏水的原因。
2. 因结冰造成的零件破损即使在保修期也是有偿修理。
3. 施工完了后或长时间不使用时，要有预防突然降温的准备，要对产品进行结冰预防。
4. 因为有结冰的危险，请不要让产品周围的温度在0°C以下。

保养

为长期保持产品的美观，请用户按以下方法维护保养。

1. 经常用软布擦拭，间或用软布蘸水擦拭。
2. 当有污垢且比较明显时，请用中性洗涤剂擦拭后充分进行水洗。

产品示意图

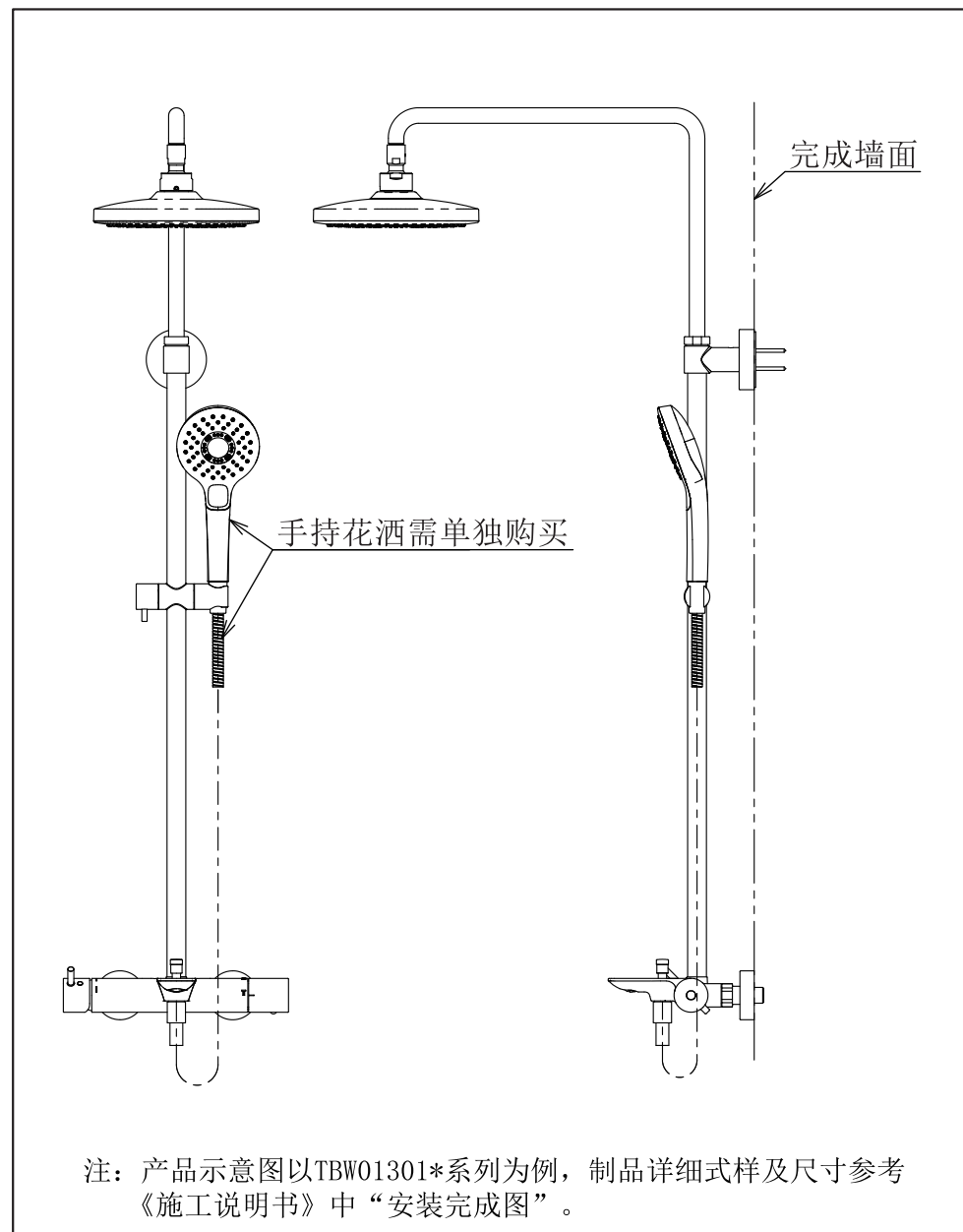

使用方法

1. 特点

- ①调节温度调节手柄即可达到期望的温度。
- ②安装了过滤网，避免了配管中的沙粒或灰尘进入部件中。

2. 各部分的名称及使用方法

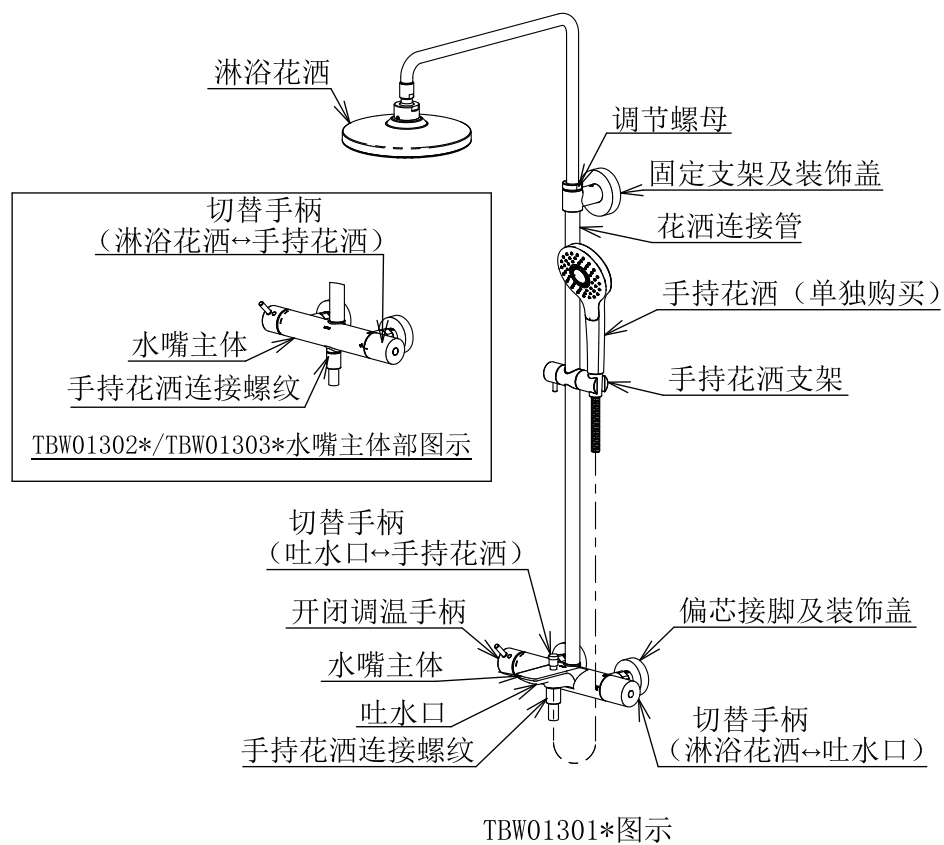

使用方法

1. 温度调节

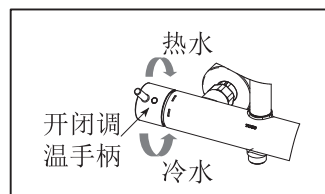

根据希望的出水温度调节手柄。(红色标识为热水侧,蓝色标识为冷水侧;冷热水调温角度约为90°)

2、吐水与止水

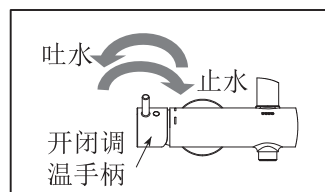

根据图示方向操作,达到吐水与止水的功能。(手柄开闭角度约为22°;本系列制品左侧手柄有“开闭”与“调温”两项功能;右侧手柄只有“切替”功能。)

3、切替

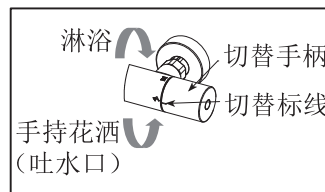

若将切换手柄向自身方向旋转,则为手持花洒吐水(TBW01301*场合下为吐水口吐水),若向后旋转,则为淋浴花洒吐水;旋到极限位置时,出水量达到最大。

4、TBW01301*场合 吐水口切替

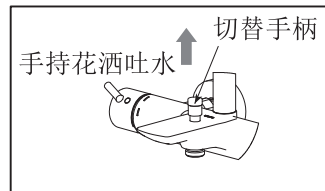

当吐水口为吐水状态时,向上提拉切换手柄,则会变更为手持花洒吐水,止水后,切换手柄自动复位。(※此套制品使用的是自动复位切替阀芯,如欲从手持花洒变更为吐水口吐水,先关闭开闭调温手柄后再打开即可,尽量避免直接按压切换手柄。)

5、花洒连接管的升降调节

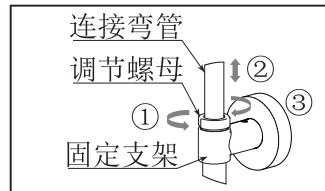

- ①逆时针拧开调节螺母,至连接弯管可上下移动的程度;
- ②上下调节连接弯管至理想高度;
- ③顺时针拧紧调节螺母,将连接弯管完全固定。

使用方法

6、手持花洒支架高度调整

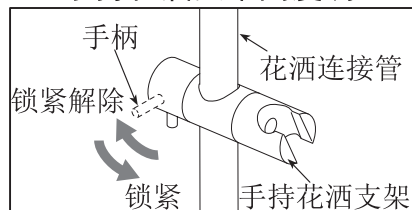

将手柄调整到“锁紧解除”位置，可上下滑动手持花洒支架，选定理想高度后，将手柄调整到“锁紧”位置即可。

7、手持花洒角度调整

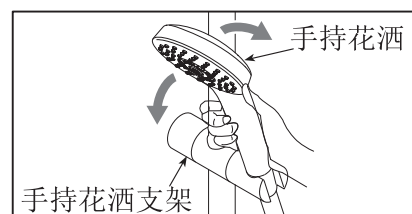

如左图所示，手握手持花洒，顺时针或逆时针旋转，将手持花洒调整到合适的角度位置放置即可。

8、多功能淋浴花洒使用 (TBW01303*)

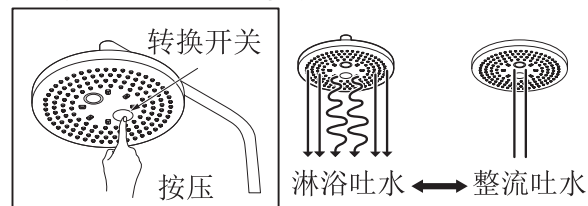

如左图所示，通过按压转换开关，实现“淋浴吐水”与“整流吐水”之间的功能转换。

9、淋浴花洒的清洁保养

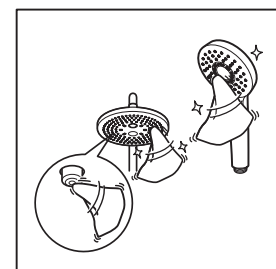

若使用时出现水线不均匀的现象，可用毛巾轻轻擦拭散水板上的小硅胶吐水口，清除异物。

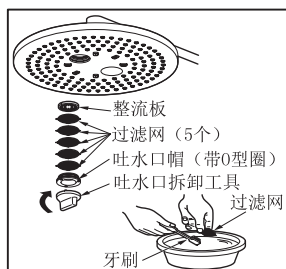

使用专用的吐水口治具拆卸吐水口，分解后注意各个部件不要丢失，用牙刷清洁过滤网。

TBW01303* 场合下

拆卸与检查

现象	检查项目
水流量小	3、5、17、18、19
手柄晃动	1、2、10、11
水流不止、漏水	2、3、4、6、7、8、9、10、14、15、16、17、18、19
连接管松动	12、13

安装后万一出现故障，请按以下要领拆卸。（以TBW01302*为例）
（此图内未拆分的零部件，需要拆卸的情况下，请联络售后服务人员进行拆卸）

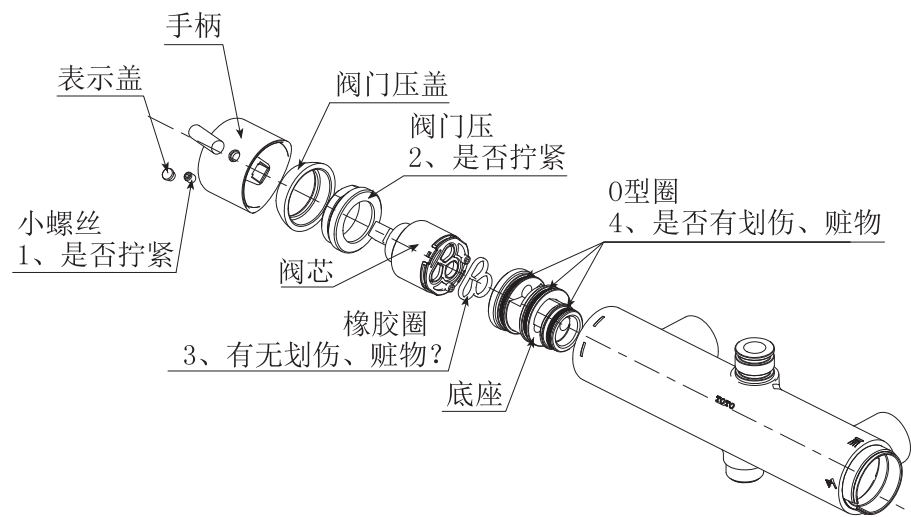

拆卸与检查

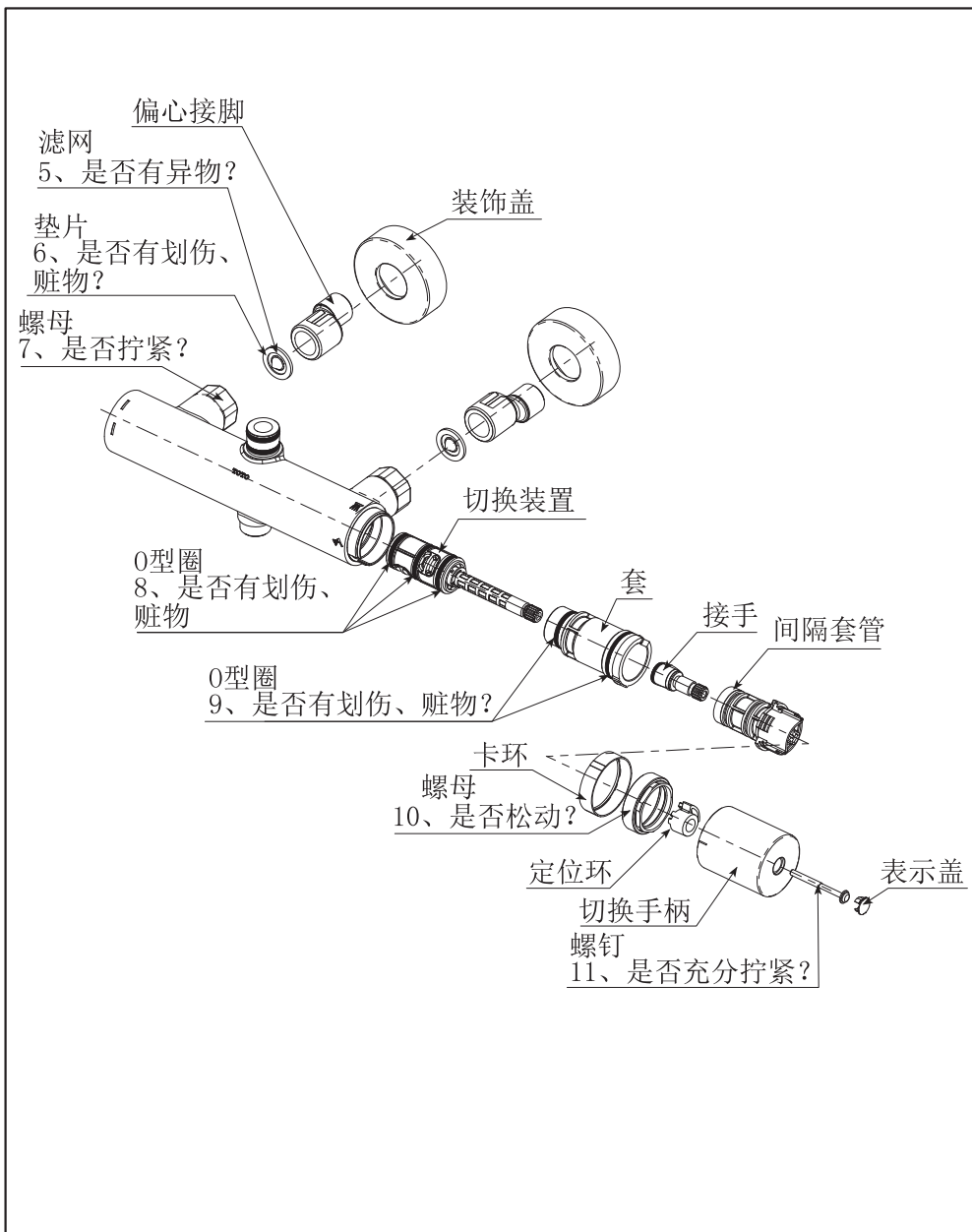

拆卸与检查

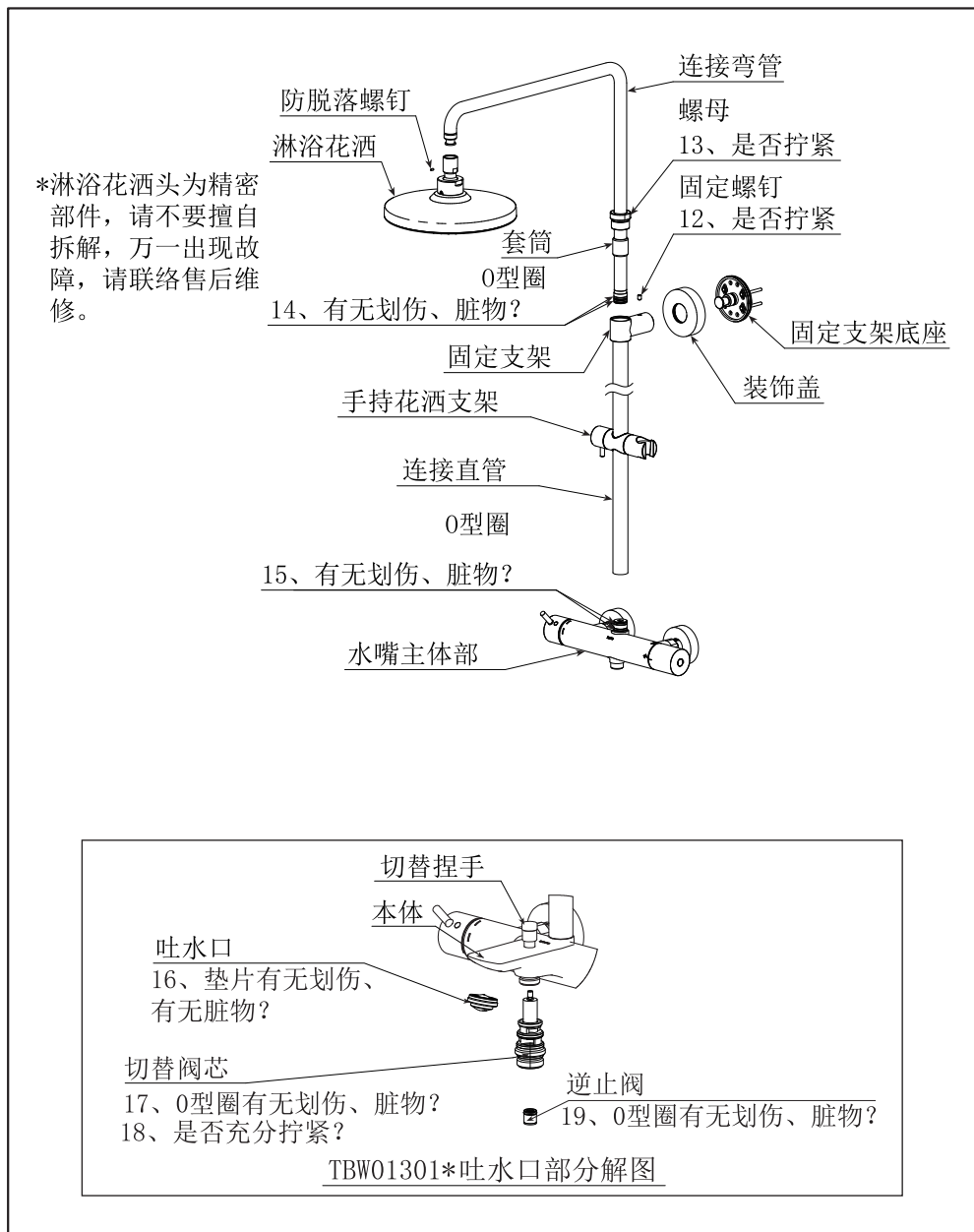

拆卸与检查

※ 安装切换手柄时

- ① 首先一定将切换装置的切割面与接手的所指示位置的平面配合调准。
- ② 其次再将接手的切割面与手柄所指示位置的平面配合调准。

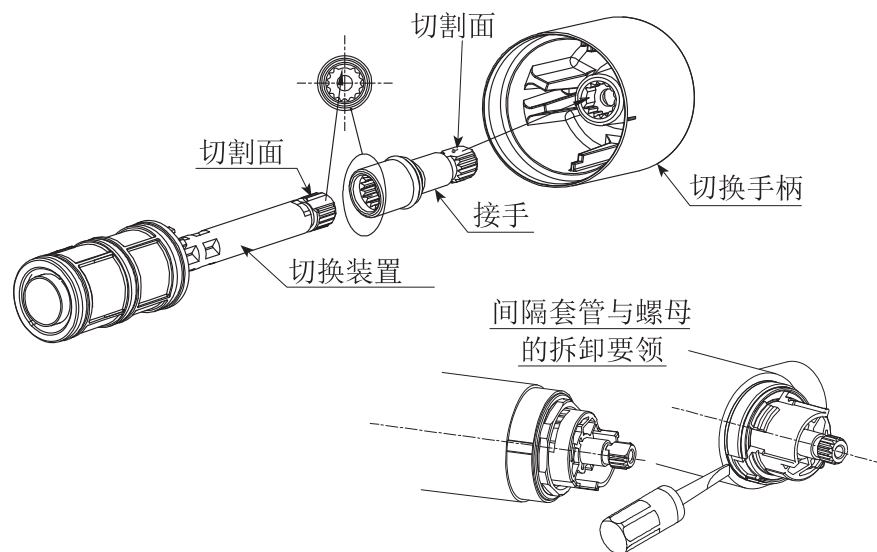

※无法拆下间隔套管时，
请将螺丝刀插入切口部。

产品保修卡

用户	
销售安装店	
购买日	
保修期	自购买日起本体及阀芯保修有效期5年， 其余部件保修期为1年

- *若上栏内容未记全，该产品保修卡将视为无效。因此请用户购买时对记入内容进行确认。
- *本产品保修卡中的保修项目仅限于产品保修卡中所约束的免费维修项目进行维修。
- *在保修期间，若产品发生故障（漏水、渗漏），请拨打全国售后服务电话报修。

维修规定

1. 保修期间，在用户正确按说明书、不干贴等指示，使用本公司产品的情况下，本公司将对有故障产品进行免费维修。
2. 在保修期内发生损坏需要得到免费维修时，请拨打全国售后服务电话报修。
3. 在保期内，下面所列场合的维修为有偿维修。
 - ① 使用不当或私自进行的不当修理及改造所造成的故障及损伤。
 - ② 安装施工时的不注意或过失造成的故障及损伤。
 - ③ 安装后又拆移等原因造成的故障及损伤。
 - ④ 超出使用范围以外的场合下使用本产品所造成的故障及损伤（如家庭用商品作为业务上商品使用。）
 - ⑤ 砂粒或污物等造成的损伤。
 - ⑥ 由于日常的维护保养不当造成的肮脏、电镀部分生锈等不良。
 - ⑦ 由于火灾、地震、水灾、雷击及其他天灾、公害、气害（液化气）、盐害及异常电压、使用指定外的电源（电压、频率）等原因造成的故障及损伤。
 - ⑧ 本产品保修卡没指定的场合。
 - ⑨ 本产品保修卡中用户姓名、销售店、安装店、购买日期未填写的场合。
 - ⑩ 不能出示购买发票的场合。
 - ⑪ 由结冰引起的故障。
4. 本产品保修卡只在中国境内有效。（香港、澳门、台湾地区除外）
5. 本产品保修卡丢失不补，请顾客妥善保管。

合格证

本品经检查判定合格

执行标准：GB 18145-2014 GB 28378-2019

产品型号：见包装箱上的标签

产品名称：见包装箱上的标签

生产日期：见包装箱上的标签

组装工厂：东陶（大连）有限公司

电 话：（0411）87624383

厂 址：大连经济技术开发区东北二街17号

东陶（中国）有限公司

全国售后服务电话：800-820-9787（固定电话）

400-820-9787（手机用户）



扫描二维码，
服务预约，方便快捷

销售商：东陶（中国）有限公司

地 址：北京市朝阳区光华路1号 北京嘉里中心北楼1915室

网 址：www.toto.com.cn

Contents

Contents

Contents.....	1
Detailed list.....	2
Use condition and attentions in use	3
Attentions in use.....	4
Attentions in use and maintenance.....	5
Product schematic diagram	6
Using method.....	7~9
Dismantle and inspection	10~13
Product warranty card	14

Detailed list

Detailed list

Control Handle Body of the Spout	1 set
Fastened Rain Shower Part	1 piece
Rain Shower Arm Elbow (including nut)	1 set
Slide Bar (including fastened support and hand shower support)	1 set
Fastened Support Backstop	1 set
Off-Center Connecting Feet	2 pieces
Escutcheon	3 pieces
Screws Accessories	1 set
Instructions for construction	1 copy
Instructions for operation	1 copy

The products using this detailed list include:



TBW01301*	"G Shower" Mixing Shower Column (Bath & Shower) (Standard Type)
TBW01302*	"G Shower" Mixing Shower Column (Shower) (Standard Type)
TBW01303*	"G Shower" Mixing Shower Column (Shower) (Standard Type)

Use condition and attentions in use

Use condition

1. Cold water supply*hot water supply pressure
Minimum pressure 0.05MPa (flow pressure)
Maximum pressure 1.0MPa (static pressure)
Recommended Operating pressure
TBW01301*.....0.12-0.5MPa (flow pressure)
TBW01302*.....0.12-0.5MPa (flow pressure)
TBW01303*.....0.15-0.5MPa (flow pressure)
Test pressure 1.6MPa(static pressure)
2. The temperature for water supply is 4~90°C. It is suggested to use the hot water temperature of 60 ± 5°C. Do not use steam to supply hot water.
3. The ambient temperature when using the product should be above 0°C and below 60°C. If the temperature is not above 0°C, deformations, cracking due to frost, etc. may occur in the handheld sprayer. Besides, internal structure of rain shower may be damaged if water temperature is higher than 60°C.
4. To prevent internal sprinkler damage, the water outlet temperature on the sprinkler side shall not exceed 60°C. It is suggested to use a temperature below 45°C.
5. Being out of use for a long time may result in internal and external rust to the faucets and being unable to be used.
6. If you want to scrap this product, do not treat it as you do for general household garbage. Please follow relevant statutes to have it treated, recovered and collected appropriately by an independent recovery system.
7. The product in these instructions has a cleaning function.
※ In order to reach the best installation and use effect, it is recommended to use [TOTO] hand shower together .

Attentions in use

-  Warning: it means that ignoring this mark and misoperation may cause serious personal injury and death.
-  Attention: it means that ignoring this mark and misoperation may cause personal injury or property loss.

Warning

1. Children are not allowed to use or can use only under the custody of adult. Such special groups as the aged and disabled should be accompanied by those with behavioral competence when using it.
2. The hot water supply side of the faucets is in a condition of high temperature. Do not allow skin to contact with the hardware surface directly. Otherwise, scalding may occur.
3. Do not reverse cold*hot water pipes. Otherwise, scalding may occur.
4. Do not use steam to supply hot water. Otherwise, scalding may occur.
5. When switching directly from the water outlet side to the shower side or from the shower side to the water outlet side, the water temperature may change. Be sure to use after measuring the water temperature with hand. Otherwise, scalding may occur.

Attentions in use

Warning

6. If a customer fails to use the self-contained water inlet filter net of our water faucet, there is such a risk as water leakage or damage due to foreign matters entering into the spool.

Attentions

1. As the ceramic cartridge is a precise component, do not dismantle it without authorization. Otherwise, such poor conditions as water leakage, etc. may be caused.
2. Do not impact the product. Otherwise, failure, water leakage may occur.
3. It is imperative to use a neutral detergent in cleaning. Other detergents than a neutral one may damage the plating coat or make the surface discolor.
4. Do not use any such detergent as acidic detergent and abstergent, polishing powder, etc. containing thick particles and nylon brush. Otherwise, the plating coat may be damaged, etc.
5. It is allowed to use a piece of soft cloth to wipe or use from time to time a piece of cloth immersed in machine oil or vehicle wax to wipe. However, do not contact with resin components. Otherwise, they may lose the gloss and become rusty.
6. It is suggested not to leave it unused for a long time. Otherwise, this may lead to internal and external rust to faucets to such a degree that it cannot be used any more, etc.
7. With the product design being updated constantly, the physical object may not coincide with the figure. However, the basic principle for installation, use is the same.
8. When pressing the control valve (hand shower ↔ water outlet), the recommended ideal pressure is 0.4Mpa; if exceeding 0.4Mpa, it will be difficult to press to switch. It is suggested to turn off the valve core first and re-open it to use.
9. Due to water supply inspection before ex-factory, there may be water remaining in the faucet. This is not a product problem.
10. Keep this product away from heat sources, such as fan heater and bath heater. Otherwise, surface and internal structure of rain shower may be damaged.
11. When using the product at a place that may freeze, anti-freezing measures should be taken properly.
If any part is damaged due to being frozen, it may cause leakage and property damage. In case of the product damage due to freezing, it requires for paid repair technician even within warranty period. Please do not use the product at ambient temperature lower than 0°C.

Attentions in use and maintenance

Anti-freezing measures

When using the product at a place that may freeze, anti-freezing measures should be taken properly.

1. It is one of the causes of water leakage when any part of the product is damaged due to freezing.
2. In case of the product damage due to freezing, it requires for paid repair technician even within warranty period.
3. After the product is installed or won't be used for a long time, preventive measures should be taken for sudden drop of temperature to prevent the product from being frozen.
4. Do not put the product at ambient temperature below 0°C for fear of freezing.

Maintenance

To maintain a beautiful appearance of the product, the user is requested to conduct maintenance and care in the following method.

1. Wipe with a piece of soft cloth frequently and use a piece of soft cloth dipped in water to wipe from time to time.
2. When dirt exists obviously, please use water to wash sufficiently after wiping with a neutral detergent.

Product schematic diagram

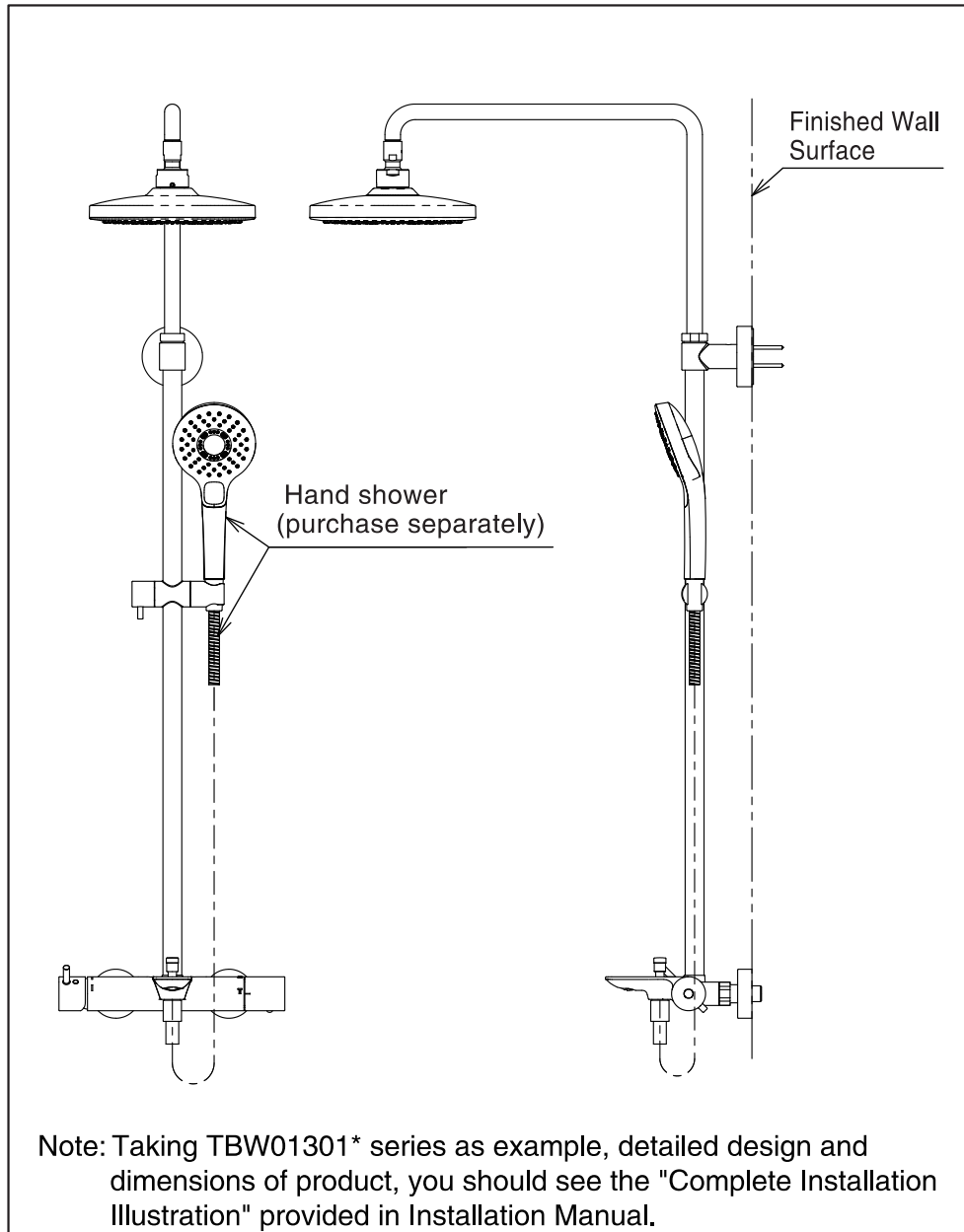

Using method

1.Features

- ① Temperature adjusting handle can be rotated to reach the expected temperature.
- ② Mesh filter has been installed to prevent the sand or dust in pipe from getting into the components.

2.Name and Usage of Individual Parts

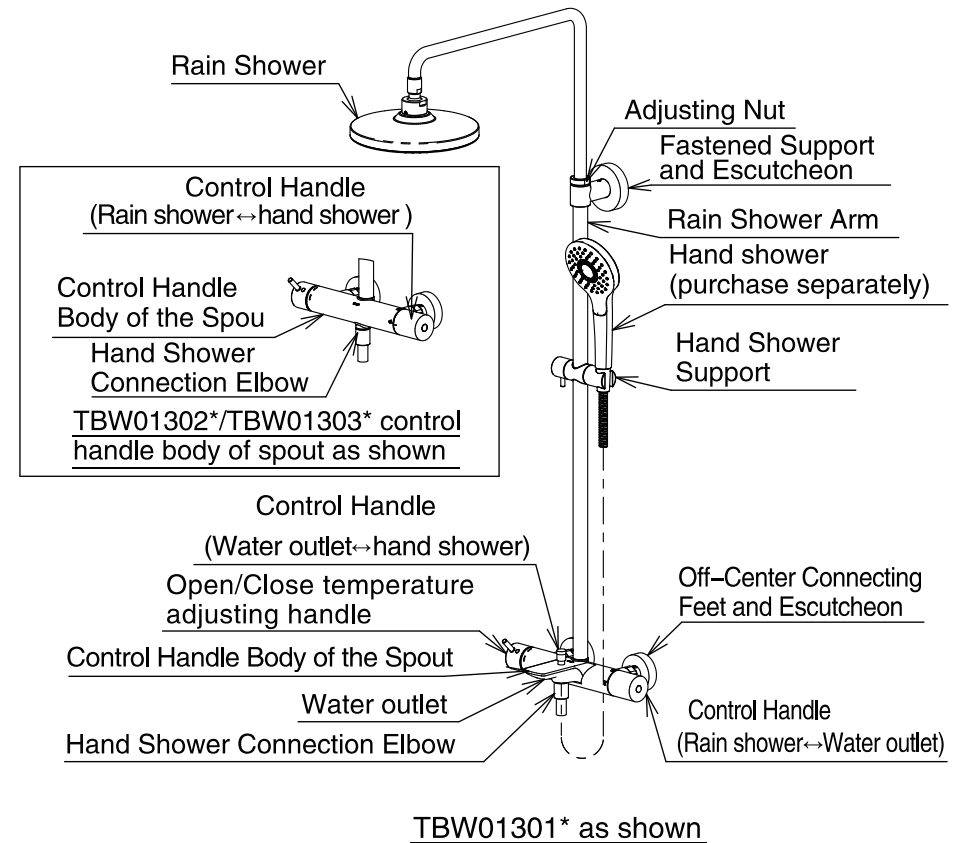

Using method

1. Temperature Adjustment

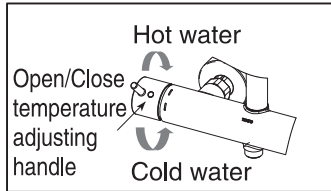

Rotate the handle according to the expected water temperature. (Red mark for hot water, blue mark for cold water; water temperature adjusting angle is about 90°.)

2. Water Outlet and Stop

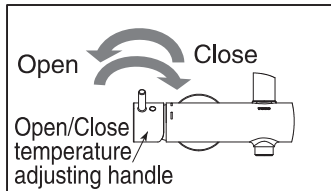

Operate as shown to start and stop watering. (Open/close angle of handle is about 22°; left handle of this series of products have two functions, "open/close" and "temperature adjustment"; and the right handle only has one function, "controlling".)

3. Control

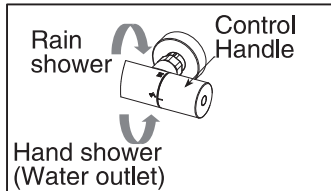

If rotating the control handle toward user, water will run out of hand shower (water will run out of water outlet with TBW01301* series products). If rotating the handle backward, water will run out of rain shower. When rotating to the extreme position, water flow reaches the highest level.

4. Water Outlet Control (TBW01301*)

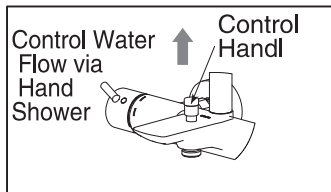

When water is running out of the spout, lift the control handle up, and water will run out of the hand shower. After stopping the water, the control handle will reset automatically. (※ This product uses the control valve core that resets automatically. If user wants to change from water running out of hand shower to the spout, please turn off the open/close control handle first and then turn it on again. Try not to press the control handle.)

5. Up and down of the rain shower slide bar

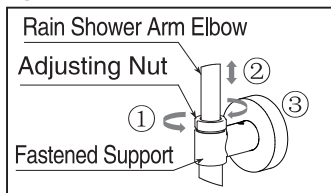

- ① Unscrew the adjusting nut anticlockwise until the rain shower arm elbow is able to move up and down;
- ② Adjust the rain shower arm elbow up and down to ideal height;
- ③ Screw the adjusting nut clockwise until fully fastened to the rain shower arm elbow.

Using method

6. Height adjustment of the hand shower support

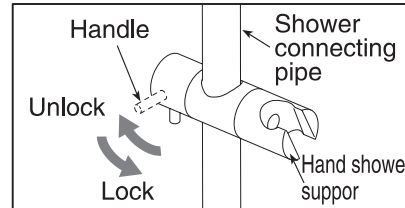

Adjust the handle to "Unlock" position, and the hand shower support can slide up and down; after choosing an ideal height, return the handle to "Lock".

7. Angle adjustment of the hand shower

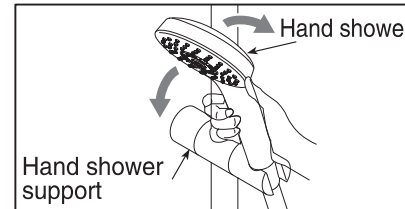

As shown on the left, hold the hand shower, rotate clockwise or anticlockwise to adjust the hand shower to a proper angle.

8. Use of multi-function of the rain shower (TBW01303*)

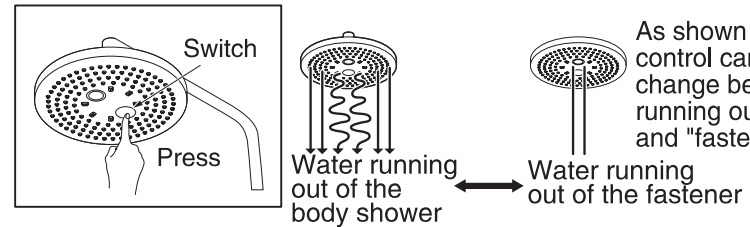

As shown on the left, the control can be pressed to change between water running out of "rain shower" and "fastener".

9. Cleaning and maintenance of the rain shower

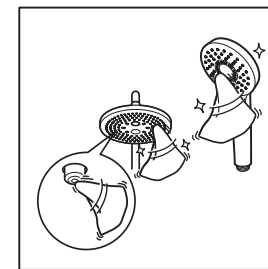

If the water outlet does not spray water evenly, use towel to gently wipe the small silicone outlets on nozzle plate to remove foreign matters.

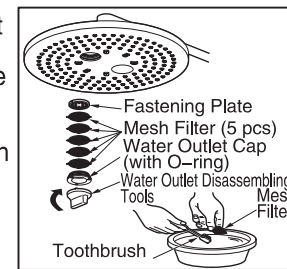

Use professional water outlet jig to disassemble the water outlet. Do not throw away the disassembled parts. And use toothbrush to clean the mesh filter.

TBW01303*

Dismantle and inspection

Occurrence	Inspecting item
Slight water flow	3、5、17、18、19
Loose handle	1、2、10、11
Water stoppage, water leakage	2、3、4、6、7、8、9、10、14、15、16、17、18、19
Loose Slide Bar	12、13

In case of product failure after installation, please dismantle according to the following main points (taking TBW01302* as an example).
 (If any part and component not disassembled in this figure needs to be removed, please contact with the after-sales service personnel for disassembly.)

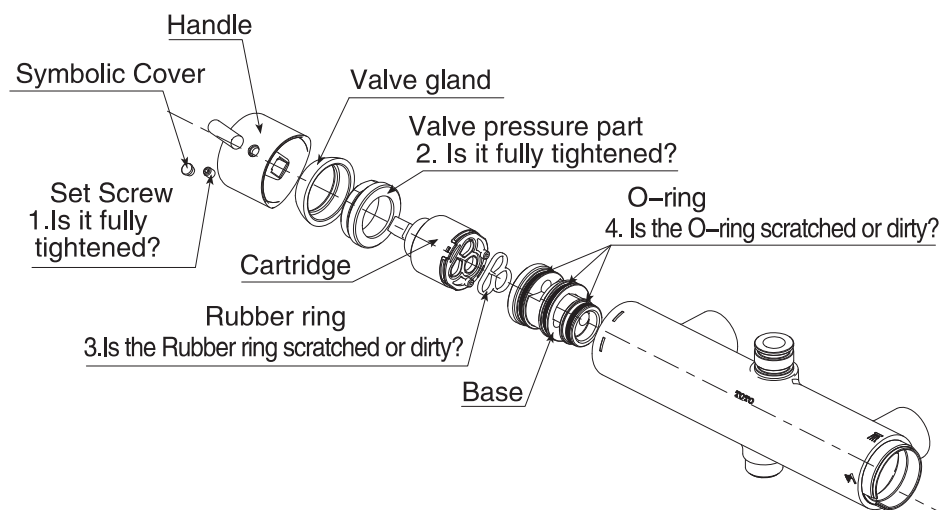

Dismantle and inspection

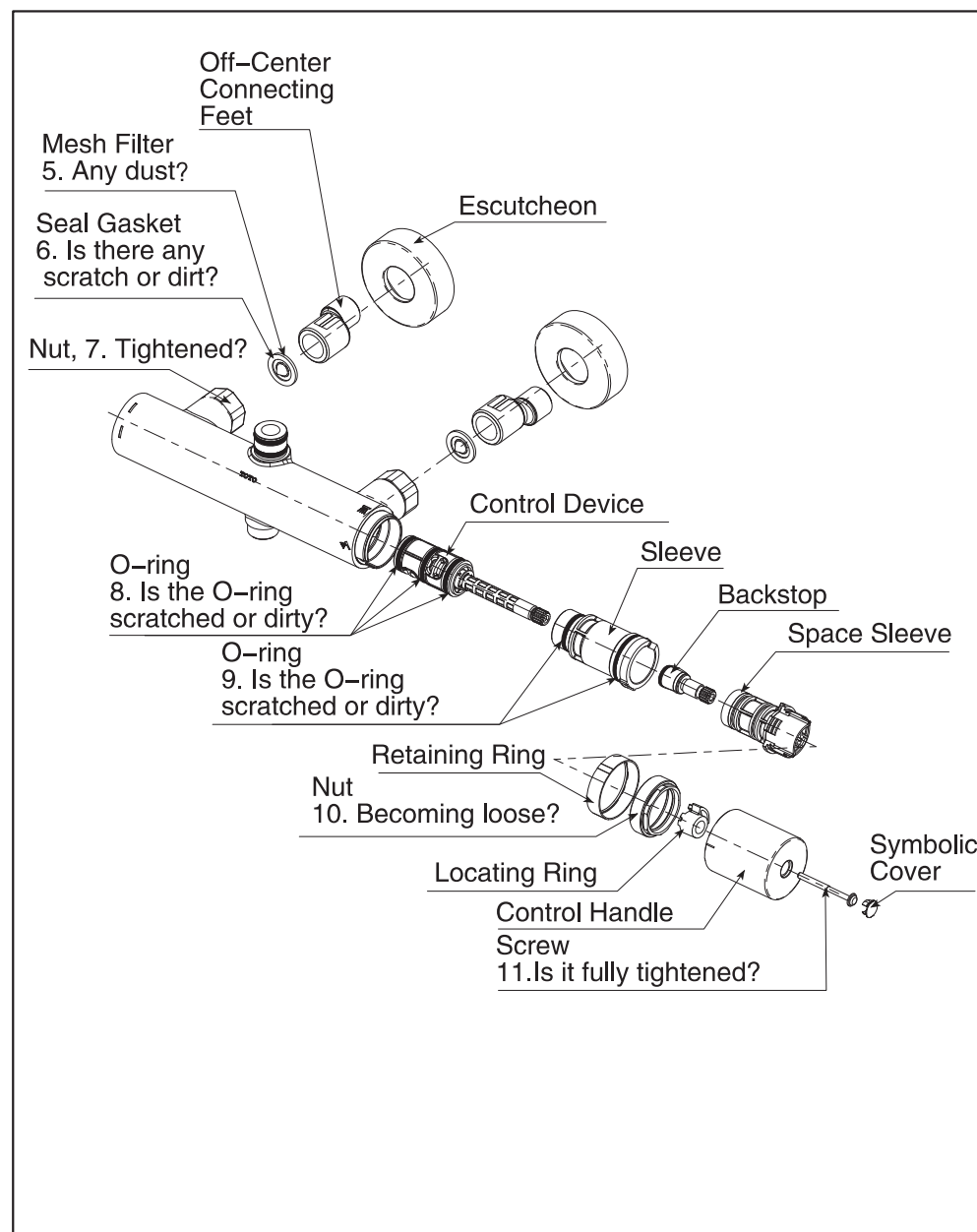

Dismantle and Inspection

* As rain shower is a precise component, do not dismantle it without authorization. Please contact the after-sales repair team in case of failure.

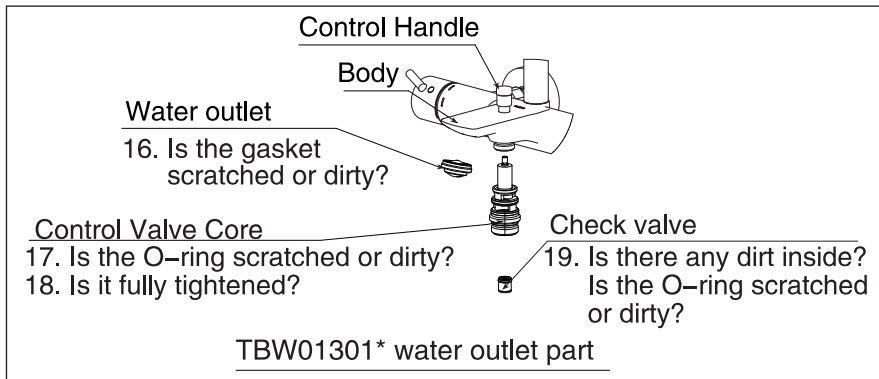
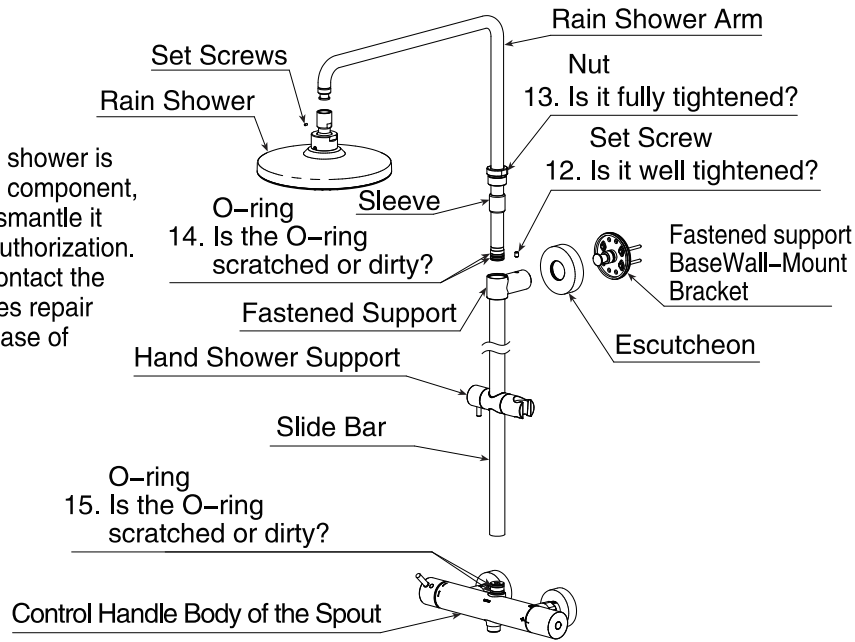

Dismantle and Inspection

※ For the installation of Control Handle.

- ① First, be sure to adjust the cutting surface of the control device and the plane indicated by the catcher.
- ② Then, adjust the cutting surface of the catcher and the plane indicated by the handle.

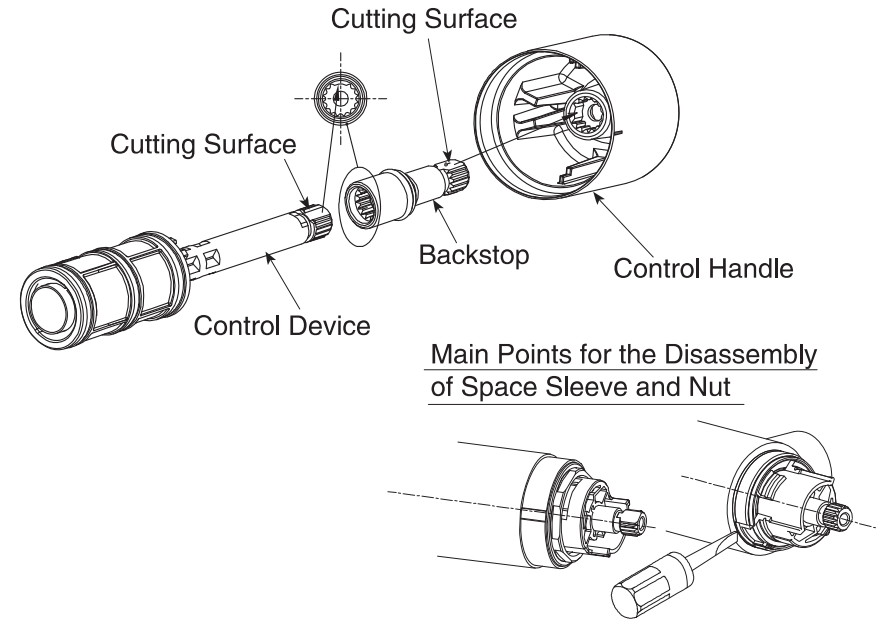

※ If the space sleeve is unable to be taken down, please insert a screwdriver into the notch part.

Product Warranty Card

User	
Sales shop or installation shop	
Date of buying	
Warranty period	Warranty period of the body and valve core is 5 years since the date of purchase, And warranty period of the other parts is 1 year.

- * If the contents in the above column are not complete, the product warranty card shall be deemed as invalid. Therefore, user should confirm the contents put in at the time of buying.
- * The warranty items in this product warranty card are only limited to the repair of the free repair items restrained in the warranty card.
- * Within the warranty period, in case of product failure (water leakage, seepage), please call national after-sales service.

Repair Regulations

1. During the warranty period, if the user uses the products of the company correctly according to relevant instructions, adhesive labels, the company will provide free repair to any faulty product.
2. When user wants free repair service for product damage within warranty the period, please call national after-sales service.
3. Within the warranty period, the repair in the following occasions is paid repair.
 - ① Any failure and damage due to any improper use or any improper repair and modification conducted privately.
 - ② Any failure and damage resulting from any carelessness or fault in installation construction.
 - ③ Any failure and damage attributed to such reasons as removal for relocation after installation, etc.
 - ④ Any failure and damage due to using this product in occasions beyond the specified scope of use (for example, home commodity is used for any business purpose).
 - ⑤ Any damage caused by sand grains or dirt, etc.
 - ⑥ Such adverse results as dirtiness, plating part rusting, etc. attributed to improper daily maintenance and care.
 - ⑦ Any failure and damage due to fire, earthquake, flood, lightning strike and other natural disasters, public nuisances, gas damage (liquefied gas), salt damage and abnormal voltage, use of any power supply (voltage, frequency) other than the specified ones, etc.
 - ⑧ The occasions not specified in this warranty.
 - ⑨ The occasion in which the user name, sales shop, installation shop or buying date is not filled in.
 - ⑩ No buying invoice can be presented.
 - ⑪ Product failure caused by freezing.
4. This product warranty card is valid within China. (except for Hong Kong, Macao and Taiwan)
5. This product warranty card shall not be reissued when being lost. Customers are requested to keep it properly.

TOTO Asia Oceania Pte. Ltd.

Telephone:65-6744-6955

FAX: 65-6841-0819

Address: 10 Eunos Road 8 #12-07 Singapore Post Centre
Singapore 408600

Website:asia.toto.com

TOTO KOREA LTD.

전화번호 : (02)-3141-8236

FAX 번호 : (02)-3141-8240

주소 : 서울시 마포구 토정로 112(상수동 ,로이코빌딩 3층)

홈페이지 : <https://kr.toto.com>